

Ref. : VPE 3449 pas

Rev. : Initial

Date : 14/11/2017

Page : 1/1

BUTTERFLY VALVE WITH HANDLE

VPE 3449-02



APPLICATION

General use : water, air, acids, etc.
"Non suitable for steam application"

GENERAL CHARACTERISTICS

Design according with EN 593.
Tightness in both ways. Wafer type with smooth ears.
Flexible sleeve adapted to the shape of the body assures low operating torque. Monobloc stem from DN40 to DN80; high and low semi stem from DN100 to DN150. High flow coefficient. Machined disc on periphery giving a low and regular torque. Unejectable stem, mounting flange according to ISO 5211.



CONSTRUCTION

12	1	Upper shaft	Stainless steel 410
11	1	Handle	Ductile iron
10	1	Collar	65Mn
9	1	Gasket	Stainless steel 201
8	1	Ring	Stainless steel 201
7	1	O ring	NBR
6	2	Upper bushing	Fiber glass + PTFE
5	1	Disc	Stainless steel 316
4	1	Lower shaft	Stainless steel 410
3	1	Sleeve	Heat EPDM
2	1	Lower bushing	Fiber glass + PTFE
1	1	Body	Cast iron EN-GJL250
Pos.	Q-ty	Description	Material

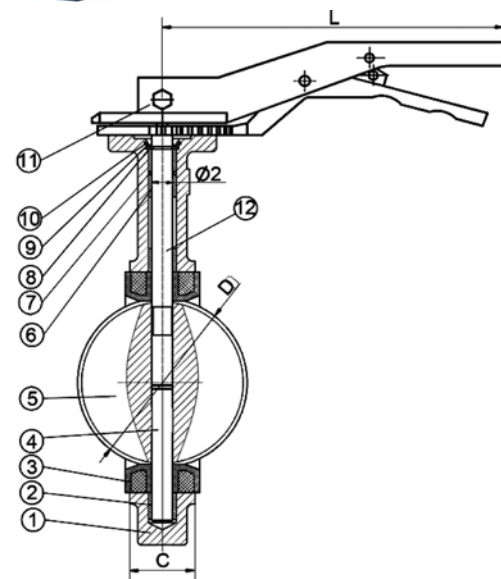
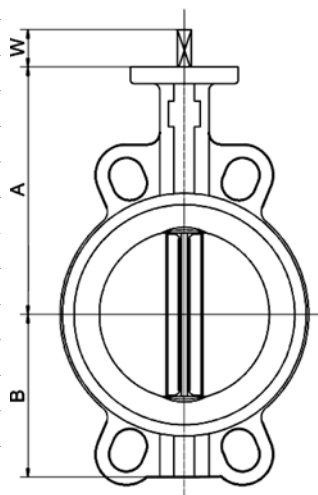

DIMENSIONS

DN		A	B	C	D	Ø2	ISO 5211	K	E	n-Ø	M	HxH	W	L	Weight (kg)
mm	inch														
40	1 1/2	135	65	33	42,5	12,6	F05	65	50	4-7	35	9x9	32	180	2,3
50	2	140	80	43	52,9	12,6	F05	65	50	4-7	35	9x9	32	180	2,86
65	2 1/2	150	89	46	64,5	12,6	F05	65	50	4-7	35	9x9	32	180	3,4
80	3	158	95	46	78,8	12,6	F05	65	50	4-7	35	9x9	32	180	3,6
100	4	176	114	52	104	15,8	F05	65	50	4-7	35	11x11	32	180	4,5
125	5	190	127	56	123	18,9	F07	90	70	4-10	55	14x14	32	220	6,96
150	6	212	139	56	156	18,9	F07	90	70	4-10	55	14x14	32	220	8,5

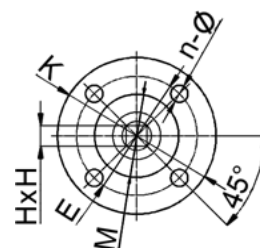

Upper flange ISO 5211

WORKING CONDITIONS

Maximum working pressure : 16 bar.
Maximum working temperature : -15°C / +130°C.
Peak temperature: -30°C / +150°C

STANDARDS

Manufacture according to the requirements of the European directive 2014/68/UE «Equipment under pressure»: modulate H.
Face to face according to standards NF EN 558-1 serie 20, ISO 5272 série 20, DIN 3202.
Mounting between flanges PN 10 / PN 16: according to EN 1092-2, BS450,AISI B16.1-5.
Adjustable between flanges ASME B16.5 Classe 150 et JIS 10K. GOST PN10/16..
Pressure test according to standards EN 12266-1, DIN 3230, BS 6755 and ISO 5208 :
Corps: 24 bar
Siège: 17.6 bar