









CONTENTS

Impact Sockets

P62-P93

Drive Type										
		Short	Deep	Extension	Magnet					
OS-2		P62	P62							P62
OS-3		P63	P64-P66	P67	P69-P74	P75	P76	P77	P77	P78
OS-4		P79-P80	P81-P82	P83	P85-P90	P91	P92	P91	P92	P93

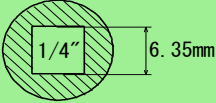
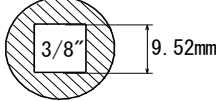
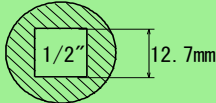
Special Sockets Quotation Worksheet

P94-P97

Accessories

P98-P100

Point Size Selector

P101-P104

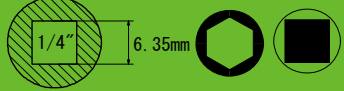

Screw Driver Bits

OS-2 1/4"(Sq6.35mm drive)

Short Sockets

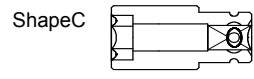
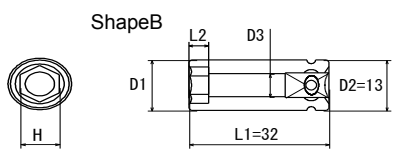

Code	Order No.	Shape	H (mm)	L2 (mm)	D1 (mm)	D3 (mm)	D2 (mm)	L1 (mm)	Weight (g)
00010522	OS-2B H8x32	B	8	4.5	13	6	13	32	23
00010523	OS-2B H10x32	C	10	5	16.5	7	13	32	32
00010524	OS-2B H12x32	C	12	6	20	9	13	32	43

Impact Sockets

Deep Sockets

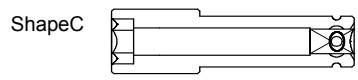
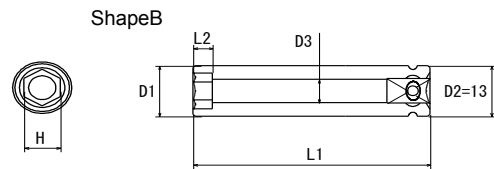

Code	Order No.	Shape	H (mm)	L2 (mm)	D1 (mm)	D3 (mm)	D2 (mm)	L1 (mm)	Weight (g)
00010525	OS-2B H8x55 DE	B	8	4.5	13	6	13	55	40
00010526	OS-2B H8x75 DE	B	8	4.5	13	6	13	75	57
00010527	OS-2B H10x55 DE	C	10	5	16.5	7	13	55	49
00010528	OS-2B H10x75 DE	C	10	5	16.5	7	13	75	64
00010529	OS-2B H12x55 DE	C	12	6	20	9	13	55	52
00010530	OS-2B H12x75 DE	C	12	6	20	9	13	75	63

Accessories

Adapter(Ball Type)

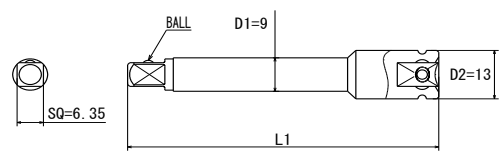

Code	Order No.	SQ (mm)	Type of Lock	D1 (mm)	D2 (mm)	L1 (mm)	Weight (g)
00010531	OS-2AD SQ6.35x50 BALL	6.35	BALL	9	13	50	30
00010532	OS-2AD SQ6.35x75 BALL	6.35	BALL	9	13	75	43
00010533	OS-2AD SQ6.35x100 BALL	6.35	BALL	9	13	100	55
00010534	OS-2AD SQ6.35x150 BALL	6.35	BALL	9	13	150	80

Point Size Selector

OS-3 3/8"(Sq9.52mm drive)

Short Sockets

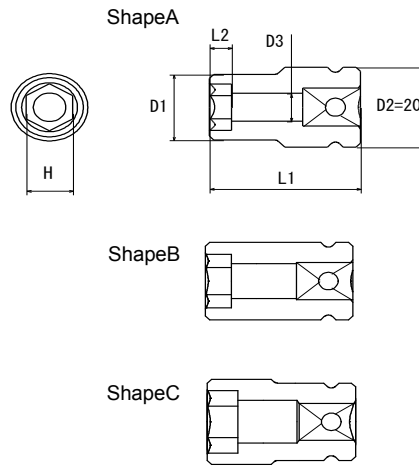

Code	Order No.	Shape	H (mm)	L2 (mm)	D1 (mm)	D3 (mm)	D2 (mm)	L1 (mm)	Weight (g)
00010535	OS-3B H8x32	A	8	4.5	13	6	20	32	37
00010536	OS-3B H10x34	A	10	5	16.5	7	20	34	50
00010537	OS-3B H12x34	B	12	6	20	9	20	34	58
00010538	OS-3B H13x34	B	13	6	20	10	20	34	53
00010539	OS-3B H14x34	C	14	7	22	11	20	34	58
00010540	OS-3B H15x34	C	15	7	23	12	20	34	59
00010541	OS-3B H17x34	C	17	8	26	14	20	34	74
*	OS-3B H19x37	C	19	10	28	15	20	37	*

Code * is custom made item.



Screw Driver Bits

OS-3 Sq9.52mm drive

Deep Sockets

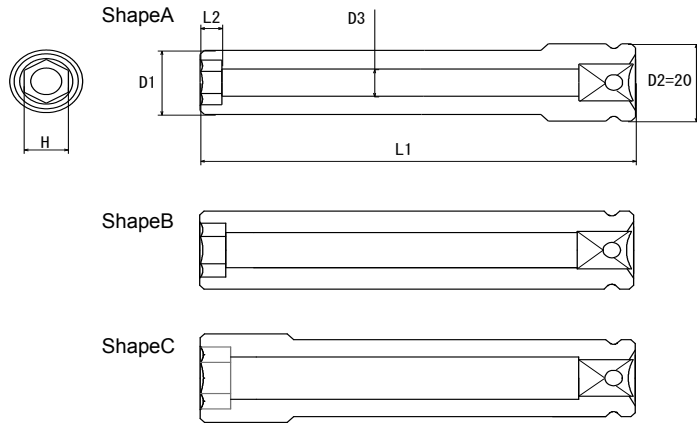

Impact Sockets

Accessories

Point Size Selector

Code	Order No.	Shape	H (mm)	L2 (mm)	D1 (mm)	D3 (mm)	D2 (mm)	L1 (mm)	Weight (g)
00010542	OS-3B H8x55 DE	A	8	4.5	13	6	20	55	66
00010543	OS-3B H8x75 DE	A	8	4.5	13	6	20	75	81
00010544	OS-3B H8x100 DE	A	8	4.5	13	6	20	100	101
00010545	OS-3B H10x55 DE	A	10	5	16.5	7	20	55	81
00010546	OS-3B H10x75 DE	A	10	5	16.5	7	20	75	108
00010547	OS-3B H10x100 DE	A	10	5	16.5	7	20	100	140
00010548	OS-3B H12x55 DE	B	12	6	20	9	20	55	100
00010549	OS-3B H12x75 DE	B	12	6	20	9	20	75	139
00010550	OS-3B H12x100 DE	B	12	6	20	9	20	100	183
00010551	OS-3B H13x55 DE	C	13	6	21	10	20	55	93
00010552	OS-3B H13x75 DE	C	13	6	21	10	20	75	130
00010553	OS-3B H13x100 DE	C	13	6	21	10	20	100	176
00010554	OS-3B H14x55 DE	C	14	7	23	11	20	55	104
00010555	OS-3B H14x75 DE	C	14	7	23	11	20	75	136
00010556	OS-3B H14x100 DE	C	14	7	23	11	20	100	182
00010557	OS-3B H15x55 DE	C	15	7	23	12	20	55	90
00010558	OS-3B H15x75 DE	C	15	7	23	12	20	75	122
00010559	OS-3B H15x100 DE	C	15	7	23	12	20	100	161
00010560	OS-3B H17x55 DE	C	17	8.5	26	13	20	55	102
00010561	OS-3B H17x75 DE	C	17	8.5	26	13	20	75	128
00010562	OS-3B H17x100 DE	C	17	8.5	26	13	20	100	162
00010563	OS-3B H19x55 DE	C	19	10	30	15	20	55	110
00010564	OS-3B H19x75 DE	C	19	10	30	15	20	75	130
00010565	OS-3B H19x100 DE	C	19	10	30	15	20	100	161

OS-3 3/8"(Sq9.52mm drive)

Deep Sockets(Thin Wall)

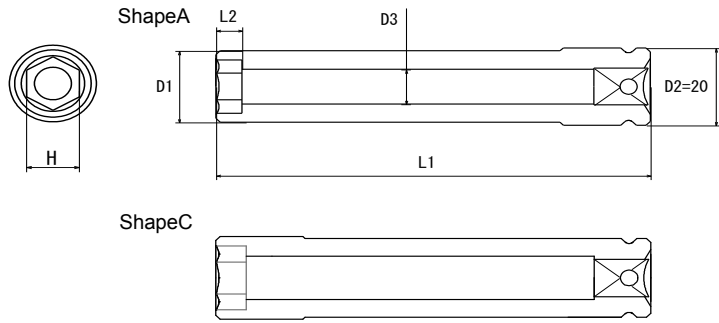

Code	Order No.	Shape	H (mm)	L2 (mm)	D1 (mm)	D3 (mm)	D2 (mm)	L1 (mm)	Weight (g)
*	OS-3B H10x15x55 DE	A	10	5	15	7	20	55	*
*	OS-3B H10x15x75 DE	A	10	5	15	7	20	75	*
*	OS-3B H10x15x100 DE	A	10	5	15	7	20	100	*
*	OS-3B H12x18.5x55 DE	A	12	6	18.5	9	20	55	*
*	OS-3B H12x18.5x75 DE	A	12	6	18.5	9	20	75	*
*	OS-3B H12x18.5x100 DE	A	12	6	18.5	9	20	100	*
*	OS-3B H14x21x55 DE	C	14	7	21	11	20	55	*
*	OS-3B H14x21x75 DE	C	14	7	21	11	20	75	*
*	OS-3B H14x21x100 DE	C	14	7	21	11	20	100	*
*	OS-3B H17x25x55 DE	C	17	8.5	25	13	20	55	*
*	OS-3B H17x25x75 DE	C	17	8.5	25	13	20	75	*
*	OS-3B H17x25x100 DE	C	17	8.5	25	13	20	100	*

Code * is custom made item.



Screw Driver Bits

OS-3 3/8"(Sq9.52mm drive)

Deep Sockets(Extra Thin Wall)

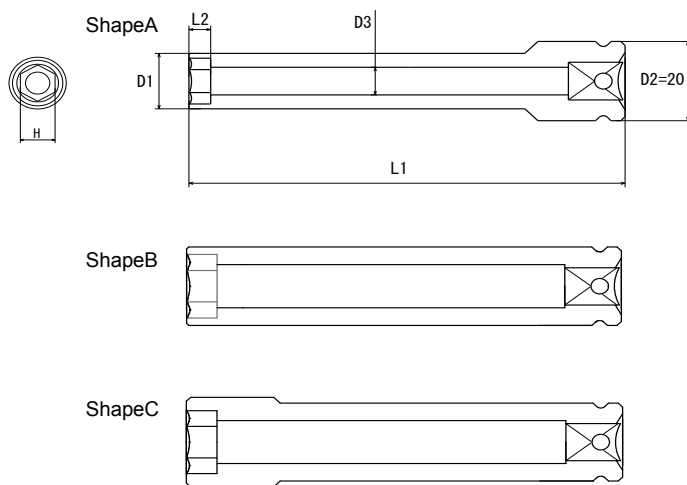

Impact Sockets

Accessories

Point Size Selector

Code	Order No.	Shape	H (mm)	L2 (mm)	D1 (mm)	D3 (mm)	D2 (mm)	L1 (mm)	Weight (g)
*	OS-3B H10x14x55 DE	A	10	5	14	7	20	55	*
*	OS-3B H10x14x75 DE	A	10	5	14	7	20	75	*
*	OS-3B H10x14x100 DE	A	10	5	14	7	20	100	*
*	OS-3B H12x17.5x55 DE	A	12	6	17.5	9	20	55	*
*	OS-3B H12x17.5x75 DE	A	12	6	17.5	9	20	75	*
*	OS-3B H12x17.5x100 DE	A	12	6	17.5	9	20	100	*
*	OS-3B H14x20x55 DE	B	14	7	20	11	20	55	*
*	OS-3B H14x20x75 DE	B	14	7	20	11	20	75	*
*	OS-3B H14x20x100 DE	B	14	7	20	11	20	100	*
*	OS-3B H17x24x55 DE	C	17	8.5	24	13	20	55	*
*	OS-3B H17x24x75 DE	C	17	8.5	24	13	20	75	*
*	OS-3B H17x24x100 DE	C	17	8.5	24	13	20	100	*

Code * is custom made item.

OS-3 3/8"(Sq9.52mm drive)

Extension Sockets

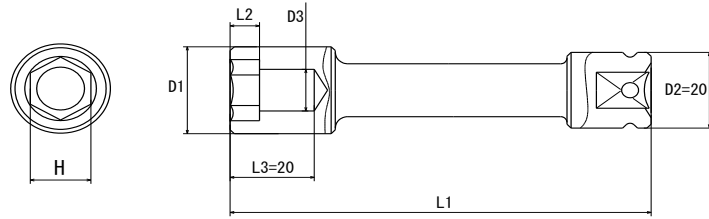

Code	Order No.	H (mm)	L2 (mm)	D1 (mm)	D3 (mm)	L3 (mm)	D2 (mm)	L1 (mm)	Weight (g)
00010566	OS-3B H8x100 EX	8	4.5	13	6	20	20	100	90
00010567	OS-3B H8x150 EX	8	4.5	13	6	20	20	150	120
00010568	OS-3B H8x200 EX	8	4.5	13	6	20	20	200	151
00010569	OS-3B H10x100 EX	10	5	16.5	7	20	20	100	102
00010570	OS-3B H10x150 EX	10	5	16.5	7	20	20	150	134
00010571	OS-3B H10x200 EX	10	5	16.5	7	20	20	200	168
*	OS-3B H10x250 EX	10	5	16.5	7	20	20	250	*
00010572	OS-3B H12x100 EX	12	6	20	9	20	20	100	133
00010573	OS-3B H12x150 EX	12	6	20	9	20	20	150	176
00010574	OS-3B H12x200 EX	12	6	20	9	20	20	200	220
*	OS-3B H12x250 EX	12	6	20	9	20	20	250	*
00010575	OS-3B H13x100 EX	13	6	21	10	20	20	100	142
00010576	OS-3B H13x150 EX	13	6	21	10	20	20	150	194
00010577	OS-3B H13x200 EX	13	6	21	10	20	20	200	246
*	OS-3B H13x250 EX	13	6	21	10	20	20	250	*
00010578	OS-3B H14x100 EX	14	7	23	11	20	20	100	160
00010579	OS-3B H14x150 EX	14	7	23	11	20	20	150	209
00010580	OS-3B H14x200 EX	14	7	23	11	20	20	200	281
*	OS-3B H14x250 EX	14	7	23	11	20	20	250	*
00010581	OS-3B H17x100 EX	17	8	26	13	20	20	100	199
00010582	OS-3B H17x150 EX	17	8	26	13	20	20	150	293
00010583	OS-3B H17x200 EX	17	8	26	13	20	20	200	380
*	OS-3B H17x250 EX	17	8	26	13	20	20	250	*

Code * is custom made item.



Screw Driver Bits

OS-3 3/8"(Sq9.52mm drive)

Universal Sockets

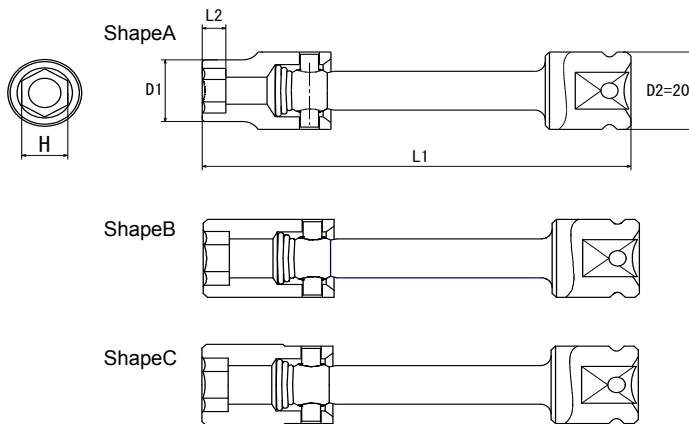

Impact Sockets

Accessories

Point Size Selector

Code	Order No.	Shape	H (mm)	L2 (mm)	D1 (mm)	D2 (mm)	L1 (mm)	Weight (g)
*	OS-3B H10x100 UN	A	10	5	16.5	20	100	*
*	OS-3B H10x150 UN	A	10	5	16.5	20	150	*
*	OS-3B H10x200 UN	A	10	5	16.5	20	200	*
*	OS-3B H12x100 UN	B	12	6	20	20	100	*
*	OS-3B H12x150 UN	B	12	6	20	20	150	*
*	OS-3B H12x200 UN	B	12	6	20	20	200	*
*	OS-3B H13x100 UN	C	13	6	21	20	100	*
*	OS-3B H13x150 UN	C	13	6	21	20	150	*
*	OS-3B H13x200 UN	C	13	6	21	20	200	*
*	OS-3B H14x100 UN	B	14	7	23	20	100	*
*	OS-3B H14x150 UN	B	14	7	23	20	150	*
*	OS-3B H14x200 UN	B	14	7	23	20	200	*
*	OS-3B H17x100 UN	B	17	8	26	20	100	*
*	OS-3B H17x150 UN	B	17	8	26	20	150	*
*	OS-3B H17x200 UN	B	17	8	26	20	200	*

Code * is custom made item.

OS-3 3/8"(Sq9.52mm drive)

Socket(Fixed Magnet)

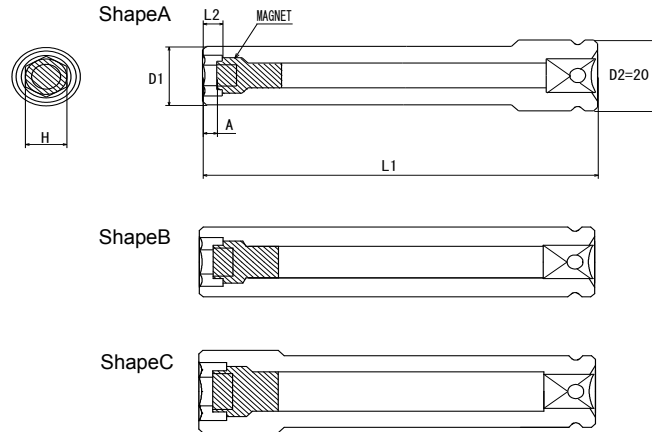

*We need A size for manufacturing sockets(Fixed Magnet).
Please jump to P95.

Code	Order No.	Shape	H (mm)	L2 (mm)	D1 (mm)	D2 (mm)	L1 (mm)	A (mm)	Weight (g)
*	OS-3B H8x32 MAG	A	8	4.5	13	20	32	within 4.5	*
*	OS-3B H8x55 MAG	A	8	4.5	13	20	55	within 4.5	*
*	OS-3B H8x75 MAG	A	8	4.5	13	20	75	within 4.5	*
*	OS-3B H8x100 MAG	A	8	4.5	13	20	100	within 4.5	*
*	OS-3B H10x34 MAG	A	10	5	16.5	20	34	within 5	*
*	OS-3B H10x55 MAG	A	10	5	16.5	20	55	within 5	*
*	OS-3B H10x75 MAG	A	10	5	16.5	20	75	within 5	*
*	OS-3B H10x100 MAG	A	10	5	16.5	20	100	within 5	*
*	OS-3B H12x34 MAG	B	12	6	20	20	34	within 6	*
*	OS-3B H12x55 MAG	B	12	6	20	20	55	within 6	*
*	OS-3B H12x75 MAG	B	12	6	20	20	75	within 6	*
*	OS-3B H12x100 MAG	B	12	6	20	20	100	within 6	*
*	OS-3B H13x34 MAG	B	13	6	20	20	34	within 6	*
*	OS-3B H13x55 MAG	C	13	6	21	20	55	within 6	*
*	OS-3B H13x75 MAG	C	13	6	21	20	75	within 6	*
*	OS-3B H13x100 MAG	C	13	6	21	20	100	within 6	*
*	OS-3B H14x34 MAG	C	14	7	22	20	34	within 7	*
*	OS-3B H14x55 MAG	C	14	7	23	20	55	within 7	*
*	OS-3B H14x75 MAG	C	14	7	23	20	75	within 7	*
*	OS-3B H14x100 MAG	C	14	7	23	20	100	within 7	*
*	OS-3B H15x34 MAG	C	15	7	23	20	34	within 7	*
*	OS-3B H15x55 MAG	C	15	7	23	20	55	within 7	*
*	OS-3B H15x75 MAG	C	15	7	23	20	75	within 7	*
*	OS-3B H15x100 MAG	C	15	7	23	20	100	within 7	*
*	OS-3B H17x34 MAG	C	17	8	26	20	34	within 8	*
*	OS-3B H17x55 MAG	C	17	8.5	26	20	55	within 8.5	*
*	OS-3B H17x75 MAG	C	17	8.5	26	20	75	within 8.5	*
*	OS-3B H17x100 MAG	C	17	8.5	26	20	100	within 8.5	*
*	OS-3B H19x37 MAG	C	19	10	28	20	37	within 10	*
*	OS-3B H19x55 MAG	C	19	10	30	20	55	within 10	*
*	OS-3B H19x75 MAG	C	19	10	30	20	75	within 10	*
*	OS-3B H19x100 MAG	C	19	10	30	20	100	within 10	*

Code * is custom made item.



OS-3 3/8"(Sq9.52mm drive)

Extension Sockets(Fixed Magnet)

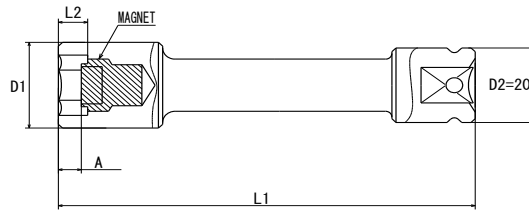
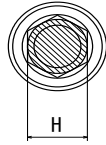

*We need A size for manufacturing sockets(Fixed Magnet).
Please jump to P95.

Code	Order No.	H (mm)	L2 (mm)	D1 (mm)	D2 (mm)	L1 (mm)	A (mm)	Weight (g)
*	OS-3B H8x100 EX MAG	8	4.5	13	20	100	within 4.5	*
*	OS-3B H8x150 EX MAG	8	4.5	13	20	150	within 4.5	*
*	OS-3B H8x200 EX MAG	8	4.5	13	20	200	within 4.5	*
*	OS-3B H10x100 EX MAG	10	5	16.5	20	100	within 5	*
*	OS-3B H10x150 EX MAG	10	5	16.5	20	150	within 5	*
*	OS-3B H10x200 EX MAG	10	5	16.5	20	200	within 5	*
*	OS-3B H10x250 EX MAG	10	5	16.5	20	250	within 5	*
*	OS-3B H12x100 EX MAG	12	6	20	20	100	within 6	*
*	OS-3B H12x150 EX MAG	12	6	20	20	150	within 6	*
*	OS-3B H12x200 EX MAG	12	6	20	20	200	within 6	*
*	OS-3B H12x250 EX MAG	12	6	20	20	250	within 6	*
*	OS-3B H13x100 EX MAG	13	6	21	20	100	within 6	*
*	OS-3B H13x150 EX MAG	13	6	21	20	150	within 6	*
*	OS-3B H13x200 EX MAG	13	6	21	20	200	within 6	*
*	OS-3B H13x250 EX MAG	13	6	21	20	250	within 6	*
*	OS-3B H14x100 EX MAG	14	7	23	20	100	within 7	*
*	OS-3B H14x150 EX MAG	14	7	23	20	150	within 7	*
*	OS-3B H14x200 EX MAG	14	7	23	20	200	within 7	*
*	OS-3B H14x250 EX MAG	14	7	23	20	250	within 7	*
*	OS-3B H17x100 EX MAG	17	8	26	20	100	within 8	*
*	OS-3B H17x150 EX MAG	17	8	26	20	150	within 8	*
*	OS-3B H17x200 EX MAG	17	8	26	20	200	within 8	*
*	OS-3B H17x250 EX MAG	17	8	26	20	250	within 8	*

Code * is custom made item.

OS-3 3/8" (Sq9.52mm drive)

Socket (Slide Magnet)

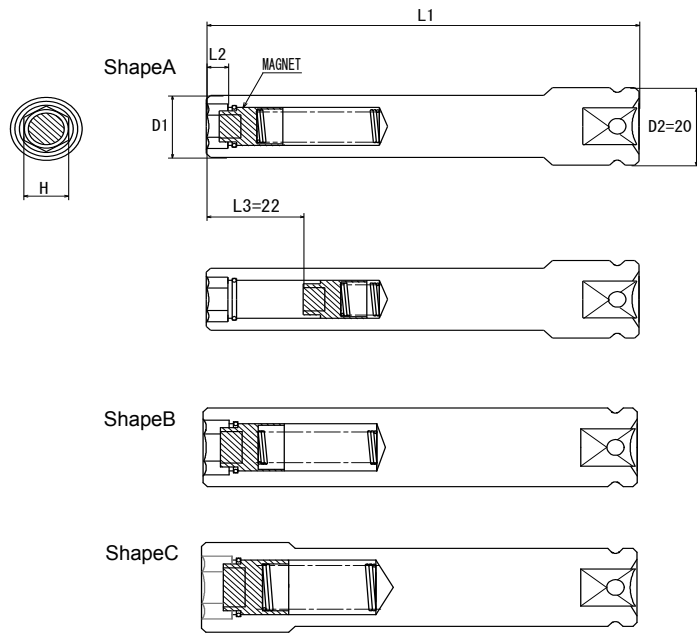

Code	Order No.	Shape	H (mm)	L2 (mm)	D1 (mm)	L3 (mm)	D2 (mm)	L1 (mm)	Weight (g)
*	OS-3B H10x75 SM	A	10	5	16.5	22	20	75	*
*	OS-3B H10x100 SM	A	10	5	16.5	22	20	100	*
*	OS-3B H12x75 SM	B	12	6	20	22	20	75	*
*	OS-3B H12x100 SM	B	12	6	20	22	20	100	*
*	OS-3B H13x75 SM	C	13	6	21	22	20	75	*
*	OS-3B H13x100 SM	C	13	6	21	22	20	100	*
*	OS-3B H14x75 SM	C	14	7	23	22	20	75	*
*	OS-3B H14x100 SM	C	14	7	23	22	20	100	*
*	OS-3B H17x75 SM	C	17	8	26	22	20	75	*
*	OS-3B H17x100 SM	C	17	8	26	22	20	100	*

Code * is custom made item.



Screw Driver Bits

OS-3 3/8"(Sq9.52mm drive)

Extension Sockets(Slide Magnet)

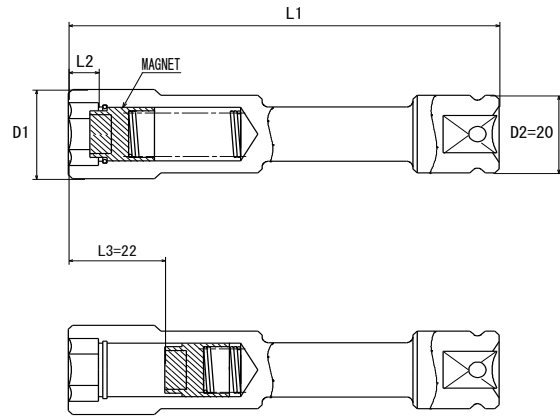
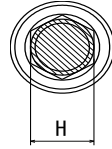

Impact Sockets

Accessories

Point Size Selector

Code	Order No.	H (mm)	L2 (mm)	D1 (mm)	L3 (mm)	D2 (mm)	L1 (mm)	Weight (g)
*	OS-3B H10x100 EX SM	10	5	16.5	22	20	100	*
*	OS-3B H10x150 EX SM	10	5	16.5	22	20	150	*
*	OS-3B H10x200 EX SM	10	5	16.5	22	20	200	*
*	OS-3B H12x100 EX SM	12	6	20	22	20	100	*
*	OS-3B H12x150 EX SM	12	6	20	22	20	150	*
*	OS-3B H12x200 EX SM	12	6	20	22	20	200	*
*	OS-3B H13x100 EX SM	13	6	21	22	20	100	*
*	OS-3B H13x150 EX SM	13	6	21	22	20	150	*
*	OS-3B H13x200 EX SM	13	6	21	22	20	200	*
*	OS-3B H14x100 EX SM	14	7	23	22	20	100	*
*	OS-3B H14x150 EX SM	14	7	23	22	20	150	*
*	OS-3B H14x200 EX SM	14	7	23	22	20	200	*
*	OS-3B H17x100 EX SM	17	8	26	22	20	100	*
*	OS-3B H17x150 EX SM	17	8	26	22	20	150	*
*	OS-3B H17x200 EX SM	17	8	26	22	20	200	*

Code * is custom made item.

OS-3 3/8"(Sq9.52mm drive)

Socket(Magnet Ring)

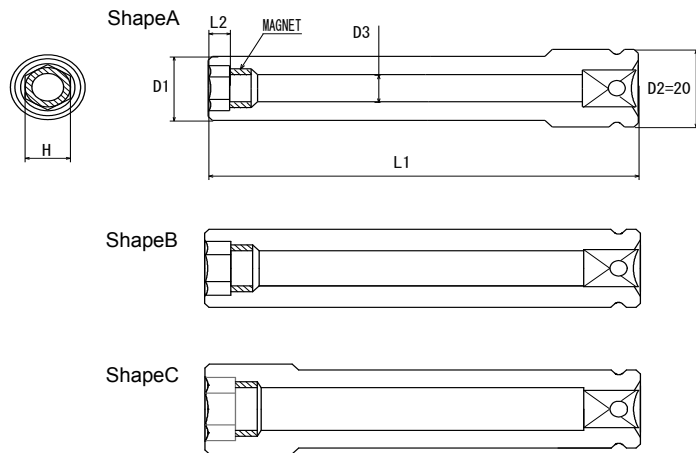

Code	Order No.	Shape	H (mm)	L2 (mm)	D1 (mm)	D3 (mm)	D2 (mm)	L1 (mm)	Weight (g)
*	OS-3B H10x34 MR	A	10	5	16.5	7	20	34	*
*	OS-3B H10x55 DE MR	A	10	5	16.5	7	20	55	*
*	OS-3B H10x75 DE MR	A	10	5	16.5	7	20	75	*
*	OS-3B H10x100 DE MR	A	10	5	16.5	7	20	100	*
*	OS-3B H12x34 MR	B	12	6	20	9	20	34	*
*	OS-3B H12x55 DE MR	B	12	6	20	9	20	55	*
*	OS-3B H12x75 DE MR	B	12	6	20	9	20	75	*
*	OS-3B H12x100 DE MR	B	12	6	20	9	20	100	*
*	OS-3B H13x34 MR	B	13	6	20	10	20	34	*
*	OS-3B H13x55 DE MR	C	13	6	21	10	20	55	*
*	OS-3B H13x75 DE MR	C	13	6	21	10	20	75	*
*	OS-3B H13x100 DE MR	C	13	6	21	10	20	100	*
*	OS-3B H14x34 MR	C	14	7	22	11	20	34	*
*	OS-3B H14x55 DE MR	C	14	7	23	11	20	55	*
*	OS-3B H14x75 DE MR	C	14	7	23	11	20	75	*
*	OS-3B H14x100 DE MR	C	14	7	23	11	20	100	*
*	OS-3B H15x34 MR	C	15	7	23	12	20	34	*
*	OS-3B H15x55 DE MR	C	15	7	23	12	20	55	*
*	OS-3B H15x75 DE MR	C	15	7	23	12	20	75	*
*	OS-3B H15x100 DE MR	C	15	7	23	12	20	100	*
*	OS-3B H17x34 MR	C	17	8	26	14	20	34	*
*	OS-3B H17x55 DE MR	C	17	8.5	26	13	20	55	*
*	OS-3B H17x75 DE MR	C	17	8.5	26	13	20	75	*
*	OS-3B H17x100 DE MR	C	17	8.5	26	13	20	100	*
*	OS-3B H19x37 MR	C	19	10	28	15	20	37	*
*	OS-3B H19x55 DE MR	C	19	10	30	15	20	55	*
*	OS-3B H19x75 DE MR	C	19	10	30	15	20	75	*
*	OS-3B H19x100 DE MR	C	19	10	30	15	20	100	*

Code * is custom made item.



Screw Driver Bits

OS-3 3/8"(Sq9.52mm drive)

Extension Sockets(Magnet Ring)

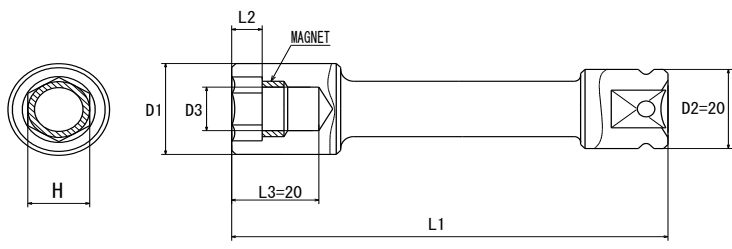

Impact Sockets

Accessories

Point Size Selector

Code	Order No.	H (mm)	L2 (mm)	D1 (mm)	D3 (mm)	L3 (mm)	D2 (mm)	L1 (mm)	Weight (g)
*	OS-3B H10x100 EX MR	10	5	16.5	7	20	20	100	*
*	OS-3B H10x150 EX MR	10	5	16.5	7	20	20	150	*
*	OS-3B H10x200 EX MR	10	5	16.5	7	20	20	200	*
*	OS-3B H10x250 EX MR	10	5	16.5	7	20	20	250	*
*	OS-3B H12x100 EX MR	12	6	20	9	20	20	100	*
*	OS-3B H12x150 EX MR	12	6	20	9	20	20	150	*
*	OS-3B H12x200 EX MR	12	6	20	9	20	20	200	*
*	OS-3B H12x250 EX MR	12	6	20	9	20	20	250	*
*	OS-3B H13x100 EX MR	13	6	21	10	20	20	100	*
*	OS-3B H13x150 EX MR	13	6	21	10	20	20	150	*
*	OS-3B H13x200 EX MR	13	6	21	10	20	20	200	*
*	OS-3B H13x250 EX MR	13	6	21	10	20	20	250	*
*	OS-3B H14x100 EX MR	14	7	23	11	20	20	100	*
*	OS-3B H14x150 EX MR	14	7	23	11	20	20	150	*
*	OS-3B H14x200 EX MR	14	7	23	11	20	20	200	*
*	OS-3B H14x250 EX MR	14	7	23	11	20	20	250	*
*	OS-3B H17x100 EX MR	17	8	26	13	20	20	100	*
*	OS-3B H17x150 EX MR	17	8	26	13	20	20	150	*
*	OS-3B H17x200 EX MR	17	8	26	13	20	20	200	*
*	OS-3B H17x250 EX MR	17	8	26	13	20	20	250	*

Code * is custom made item.

OS-3 3/8"(Sq9.52mm drive)

Hexagon

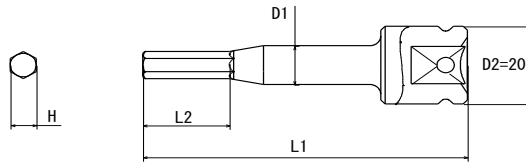

Code	Order No.	H (mm)	L2 (mm)	D1 (mm)	D2 (mm)	L1 (mm)	Weight (g)
*	OS-3X H4x50	4	10	8	20	50	*
00010584	OS-3X H4x75	4	10	8	20	75	54
00010585	OS-3X H4x100	4	10	8	20	100	64
*	OS-3X H5x50	5	10	10	20	50	*
00010586	OS-3X H5x75	5	15	10	20	75	59
00010587	OS-3X H5x100	5	15	10	20	100	75
*	OS-3X H6x50	6	10	10	20	50	*
00010588	OS-3X H6x75	6	20	10	20	75	64
00010589	OS-3X H6x100	6	20	10	20	100	79
*	OS-3X H8x50	8	15	10	20	50	*
00010590	OS-3X H8x75	8	20	10	20	75	67
00010591	OS-3X H8x100	8	20	10	20	100	82
*	OS-3X H10x50	10	15	13	20	50	*
*	OS-3X H10x75	10	20	13	20	75	*
*	OS-3X H10x100	10	20	13	20	100	*

Code * is custom made item.

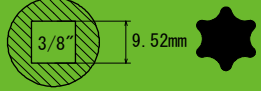

Screw Driver Bits

OS-3 3/8"(Sq9.52mm drive)

Hex-wave

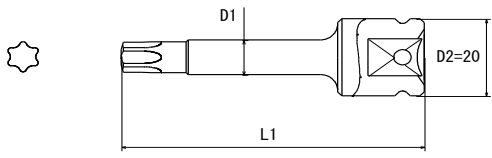

Impact Sockets

Code	Order No.	Point Size	D1 (mm)	D2 (mm)	L1 (mm)	Weight (g)
*	OS-3T T25x50	T25	9	20	50	*
00010592	OS-3T T25x70	T25	9	20	70	55
00010593	OS-3T T25x100	T25	9	20	100	70
*	OS-3T T27x50	T27	9	20	50	*
00010594	OS-3T T27x70	T27	9	20	70	55
00010595	OS-3T T27x100	T27	9	20	100	70
*	OS-3T T30x50	T30	9	20	50	*
00010596	OS-3T T30x70	T30	9	20	70	60
00010597	OS-3T T30x100	T30	9	20	100	75
*	OS-3T T40x50	T40	9	20	50	*
00010598	OS-3T T40x70	T40	9	20	70	61
00010599	OS-3T T40x100	T40	9	20	100	76
*	OS-3T T45x50	T45	9	20	50	*
00010600	OS-3T T45x70	T45	9	20	70	61
00010601	OS-3T T45x100	T45	9	20	100	76
*	OS-3T T50x50	T50	9	20	50	*
00010602	OS-3T T50x70	T50	9	20	70	61
00010603	OS-3T T50x100	T50	9	20	100	76
*	OS-3T T55x50	T55	12	20	50	*
00010604	OS-3T T55x70	T55	12	20	70	77
00010605	OS-3T T55x100	T55	12	20	100	104

Code * is custom made item.

Accessories

Point Size Selector

OS-3 3/8"(Sq9.52mm drive)

External Hex-wave

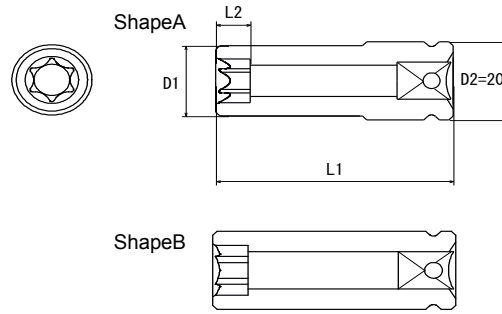

Code	Order No.	Shape	Point Size	L2 (mm)	D1 (mm)	D2 (mm)	L1 (mm)	Weight (g)
*	OS-3E E8x34	A	E8	6	13	20	34	*
*	OS-3E E8x55	A	E8	6	13	20	55	*
*	OS-3E E8x75	A	E8	6	13	20	75	*
*	OS-3E E10x34	A	E10	7	16	20	34	*
*	OS-3E E10x55	A	E10	7	16	20	55	*
*	OS-3E E10x75	A	E10	7	16	20	75	*
*	OS-3E E12x34	A	E12	8	18	20	34	*
*	OS-3E E12x55	A	E12	8	18	20	55	*
*	OS-3E E12x75	A	E12	8	18	20	75	*
*	OS-3E E14x34	B	E14	8	20	20	34	*
*	OS-3E E14x55	B	E14	8	20	20	55	*
*	OS-3E E14x75	B	E14	8	20	20	75	*

Code * is custom made item.

Sockets for Stud Bolt

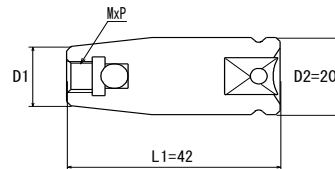

Code	Order No.	Screw Size (mm)	D1 (mm)	D2 (mm)	L1 (mm)	Weight (g)
*	OS-3SB (M5x0.8P)x42	M5-P0.8	13	20	42	*
*	OS-3SB (M6x1.0P)x42	M6xP1.0	13	20	42	*
*	OS-3SB (M8x1.25P)x42	M8xP1.25	15	20	42	*
*	OS-3SB (M10x1.25P)x42	M10xP1.25	16	20	42	*
*	OS-3SB (M10x1.5P)x42	M10xP1.5	16	20	42	*

Code * is custom made item.

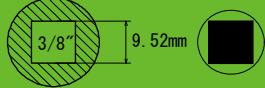

Screw Driver Bits

OS-3 3/8"(Sq9.52mm drive)

Adapter(Pin Type)

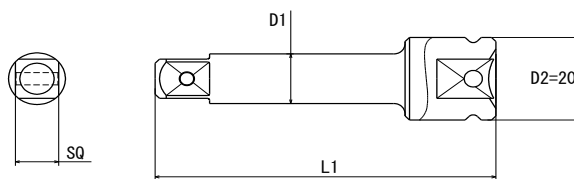

Impact Sockets

Code	Order No.	SQ (mm)	Type of Lock	D1 (mm)	D2 (mm)	L1 (mm)	Weight (g)
00010606	OS-3AD SQ9.52x50	9.52	PIN	12	20	50	60
00010607	OS-3AD SQ9.52x75	9.52	PIN	12	20	75	82
00010608	OS-3AD SQ9.52x100	9.52	PIN	12	20	100	104
00010609	OS-3AD SQ9.52x150	9.52	PIN	12	20	150	149
00010610	OS-3AD SQ9.52x200	9.52	PIN	12	20	200	193
00010611	OS-3AD SQ9.52x250	9.52	PIN	12	20	250	236
00010612	OS-3AD SQ9.52x300	9.52	PIN	12	20	300	282
00010613	OS-3AD SQ12.7x37	12.7	PIN	—	20	37	96

Accessories

Adapter(Ball Type)

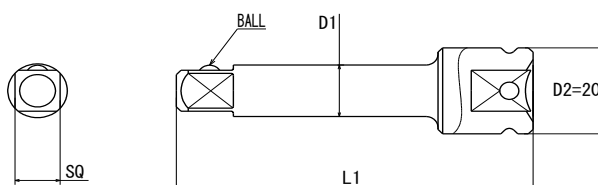

Point Size Selector

Code	Order No.	SQ (mm)	Type of Lock	D1 (mm)	D2 (mm)	L1 (mm)	Weight (g)
00010614	OS-3AD SQ9.52x50 BALL	9.52	BALL	12	20	50	60
00010615	OS-3AD SQ9.52x75 BALL	9.52	BALL	12	20	75	82
00010616	OS-3AD SQ9.52x100 BALL	9.52	BALL	12	20	100	104
00010617	OS-3AD SQ9.52x150 BALL	9.52	BALL	12	20	150	149
00010618	OS-3AD SQ9.52x200 BALL	9.52	BALL	12	20	200	193
00010619	OS-3AD SQ9.52x250 BALL	9.52	BALL	12	20	250	236
00010620	OS-3AD SQ9.52x300 BALL	9.52	BALL	12	20	300	282
00010621	OS-3AD SQ12.7x37 BALL	12.7	BALL	—	20	37	55

OS-4 1/2"(Sq12.7mm drive)

Short Sockets

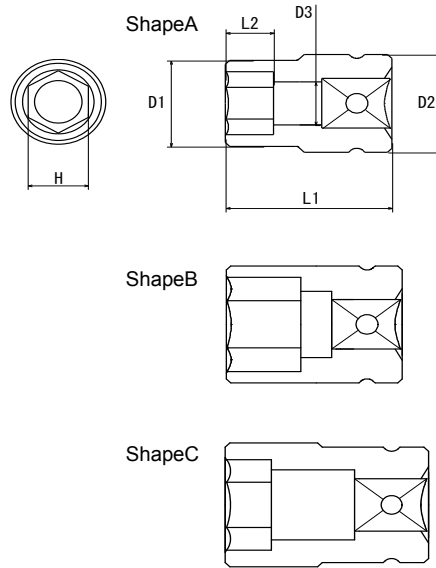

Code	Order No.	Shape	H (mm)	L2 (mm)	D1 (mm)	D3 (mm)	D2 (mm)	L1 (mm)	Weight (g)
00010622	OS-4B H10x35	A	10	7	16.5	8	25	35	62
00010623	OS-4B H12x35	A	12	6	20	9	25	35	75
*	OS-4B H13x35	A	13	8	21	11	24.5	35	*
00010624	OS-4B H14x38	A	14	11	22	11	25	38	80
*	OS-4B H15x38	A	15	10	24.5	13	26.5	38	*
00010625	OS-4B H17x38	B	17	11	26	13	26	38	98
00010626	OS-4B H19x40	B	19	11	28	17	28	40	133
00010627	OS-4B H21x40	B	21	17	30	17	30	40	129
00010628	OS-4B H22x43	C	22	14	30	18	28	43	109
00010629	OS-4B H24x43	C	24	14	32	20	28	43	124

Code * is custom made item.

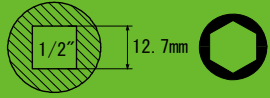

Screw Driver Bits

OS-4 1/2"(Sq12.7mm drive)

Short Sockets

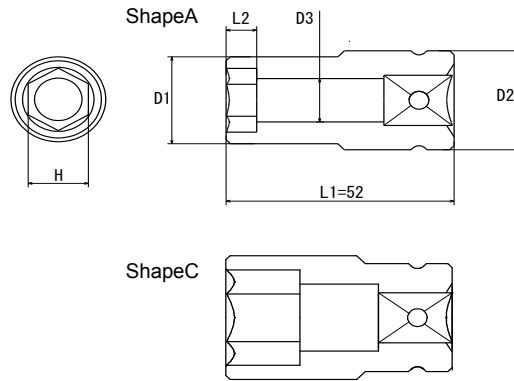

Impact Sockets

Accessories

Point Size Selector

Code	Order No.	Shape	H (mm)	L2 (mm)	D1 (mm)	D3 (mm)	D2 (mm)	L1 (mm)	Weight (g)
00010630	OS-4B H10x52	A	10	15	16.5	8	24.5	52	104
00010631	OS-4B H12x52	A	12	6	20	9	25	52	116
*	OS-4B H13x52	A	13	15	20.5	11	24.5	52	*
00010632	OS-4B H14x52	A	14	7	22	11	25	52	120
*	OS-4B H15x52	A	15	17	23.5	13	26.5	52	*
00010633	OS-4B H17x52	A	17	8	26	13	28	52	164
00010634	OS-4B H19x52	C	19	10	30	17	28	52	170
00010635	OS-4B H21x52	C	21	17	31.5	17	27.5	52	176
00010636	OS-4B H22x52	C	22	20	33	18	27.5	52	177
00010637	OS-4B H24x52	C	24	20	35.5	20	27.5	52	187

Code * is custom made item.

OS-4 1/2"(Sq12.7mm drive)

Deep Sockets

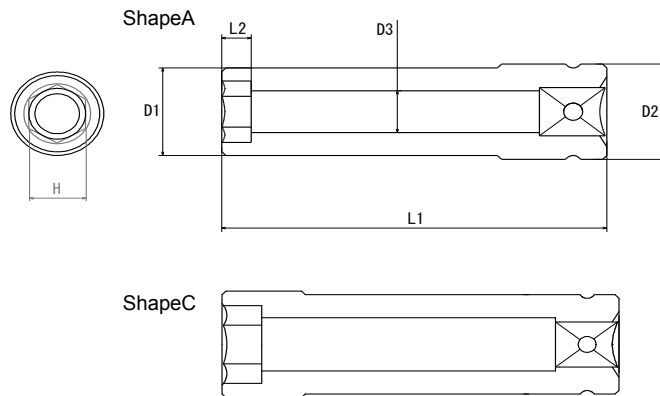

Code	Order No.	Shape	H (mm)	L2 (mm)	D1 (mm)	D3 (mm)	D2 (mm)	L1 (mm)	Weight (g)
00010638	OS-4B H10x75 DE	A	10	5	16.5	7	25	75	132
00010639	OS-4B H10x100 DE	A	10	5	16.5	7	25	100	166
00010640	OS-4B H12x75 DE	A	12	6	20	9	25	75	161
00010641	OS-4B H12x100 DE	A	12	6	20	9	25	100	211
*	OS-4B H13x75 DE	A	13	6	21	10	25	75	*
*	OS-4B H13x100 DE	A	13	6	21	10	25	100	*
00010642	OS-4B H14x75 DE	A	14	11	23	11	25	75	182
00010643	OS-4B H14x100 DE	A	14	7	23	11	25	100	248
00010644	OS-4B H17x75 DE	A	17	11	26	13	28	75	228
00010645	OS-4B H17x100 DE	A	17	8	26	13	28	100	312
00010646	OS-4B H19x75 DE	C	19	17	30	15	28	75	255
00010647	OS-4B H19x100 DE	C	19	10	30	15	28	100	341
*	OS-4B H21x75 DE	C	21	12	32	17	28	75	*
*	OS-4B H21x100 DE	C	21	12	32	17	28	100	*
*	OS-4B H22x75 DE	C	22	13	32	19	28	75	*
*	OS-4B H22x100 DE	C	22	13	32	19	28	100	*
*	OS-4B H24x75 DE	C	24	15	36	20	28	75	*
*	OS-4B H24x100 DE	C	24	15	36	20	28	100	*

Code * is custom made item.



Screw Driver Bits

OS-4 1/2"(Sq12.7mm drive)

Deep Sockets(Thin Wall)

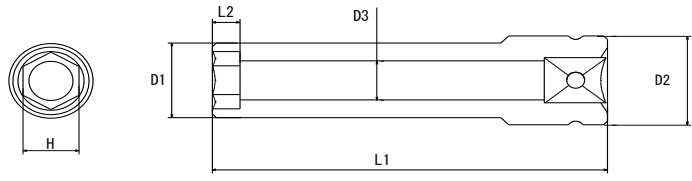

Code	Order No.	H (mm)	L2 (mm)	D1 (mm)	D3 (mm)	D2 (mm)	L1 (mm)	Weight (g)
*	OS-4B H14x21x75 DE	14	11	21	11	25	75	*
*	OS-4B H14x21x100 DE	14	7	21	11	25	100	*
*	OS-4B H17x25x75 DE	17	11	25	13	28	75	*
*	OS-4B H17x25x100 DE	17	8	25	13	28	100	*

Code * is custom made item.

Impact Sockets

Deep Sockets(Extra Thin Wall)

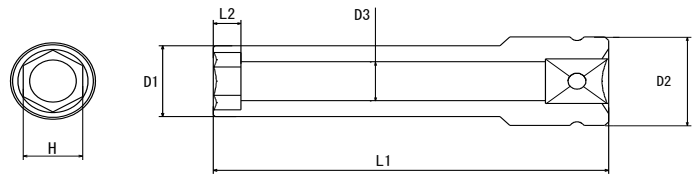

Code	Order No.	H (mm)	L2 (mm)	D1 (mm)	D3 (mm)	D2 (mm)	L1 (mm)	Weight (g)
*	OS-4B H14x20x75 DE	14	11	20	11	25	75	*
*	OS-4B H14x20x100 DE	14	7	20	11	25	100	*
*	OS-4B H17x24x75 DE	17	11	24	13	28	75	*
*	OS-4B H17x24x100 DE	17	8	24	13	28	100	*

Code * is custom made item.

Accessories

Point Size Selector

OS-4 1/2"(Sq12.7mm drive)

Extension Sockets

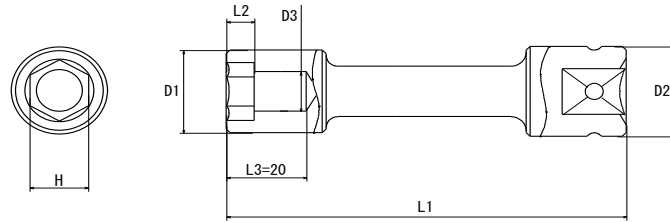

Code	Order No.	H (mm)	L2 (mm)	D1 (mm)	D3 (mm)	L3 (mm)	D2 (mm)	L1 (mm)	Weight (g)
00010648	OS-4B H10x100 EX	10	5	16.5	7	20	25	100	133
00010649	OS-4B H10x150 EX	10	5	16.5	7	20	25	150	163
00010650	OS-4B H10x200 EX	10	5	16.5	7	20	25	200	197
*	OS-4B H10x250 EX	10	5	16.5	7	20	25	250	*
00010651	OS-4B H12x100 EX	12	6	20	9	20	25	100	160
00010652	OS-4B H12x150 EX	12	6	20	9	20	25	150	203
00010653	OS-4B H12x200 EX	12	6	20	9	20	25	200	251
*	OS-4B H12x250 EX	12	6	20	9	20	25	250	*
*	OS-4B H13x100 EX	13	6	21	10	20	25	100	*
*	OS-4B H13x150 EX	13	6	21	10	20	25	150	*
*	OS-4B H13x200 EX	13	6	21	10	20	25	200	*
*	OS-4B H13x250 EX	13	6	21	10	20	25	250	*
00010655	OS-4B H14x100 EX	14	7	23	11	20	25	100	189
00010656	OS-4B H14x150 EX	14	7	23	11	20	25	150	252
00010657	OS-4B H14x200 EX	14	7	23	11	20	25	200	309
*	OS-4B H14x250 EX	14	7	23	11	20	25	250	*
00010658	OS-4B H17x100 EX	17	8	26	13	20	28	100	252
00010659	OS-4B H17x150 EX	17	8	26	13	20	28	150	341
00010660	OS-4B H17x200 EX	17	8	26	13	20	28	200	431
*	OS-4B H17x250 EX	17	8	26	13	20	28	250	*
00010661	OS-4B H19x100 EX	19	10	30	15	20	28	100	297
00010662	OS-4B H19x150 EX	19	10	30	15	20	28	150	408
00010663	OS-4B H19x200 EX	19	10	30	15	20	28	200	521
*	OS-4B H19x250 EX	19	10	30	15	20	28	250	*

Code * is custom made item.



Screw Driver Bits

OS-4 1/2"(Sq12.7mm drive)

Universal Sockets

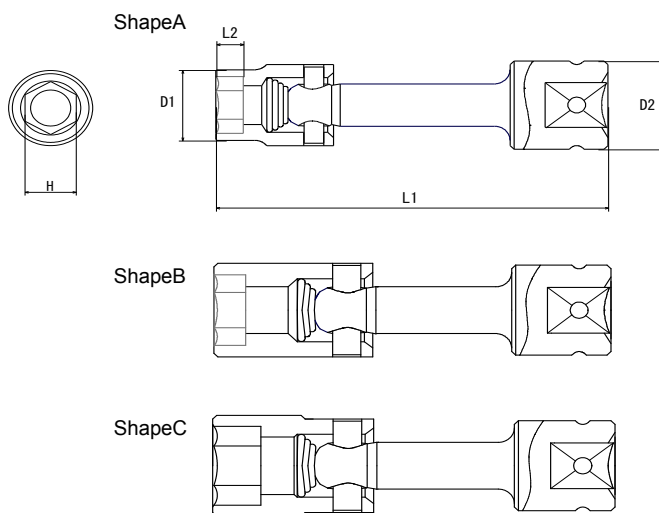

Impact Sockets

Accessories

Point Size Selector

Code	Order No.	Shape	H (mm)	L2 (mm)	D1 (mm)	D2 (mm)	L1 (mm)	Weight (g)
*	OS-4B H10x100 UN	A	10	5	16.5	25	100	*
*	OS-4B H10x150 UN	A	10	5	16.5	25	150	*
*	OS-4B H10x200 UN	A	10	5	16.5	25	200	*
*	OS-4B H12x100 UN	B	12	6	20	25	100	*
*	OS-4B H12x150 UN	B	12	6	20	25	150	*
*	OS-4B H12x200 UN	B	12	6	20	25	200	*
*	OS-4B H13x100 UN	C	13	6	21	25	100	*
*	OS-4B H13x150 UN	C	13	6	21	25	150	*
*	OS-4B H13x200 UN	C	13	6	21	25	200	*
*	OS-4B H14x100 UN	B	14	7	23	25	100	*
*	OS-4B H14x150 UN	B	14	7	23	25	150	*
*	OS-4B H14x200 UN	B	14	7	23	25	200	*
*	OS-4B H17x100 UN	B	17	8	26	28	100	*
*	OS-4B H17x150 UN	B	17	8	26	28	150	*
*	OS-4B H17x200 UN	B	17	8	26	28	200	*
*	OS-4B H19x100 UN	C	19	10	30	28	100	*
*	OS-4B H19x150 UN	C	19	10	30	28	150	*
*	OS-4B H19x200 UN	C	19	10	30	28	200	*

Code * is custom made item.

OS-4 1/2"(Sq12.7mm drive)

Socket(Fixed Magnet)

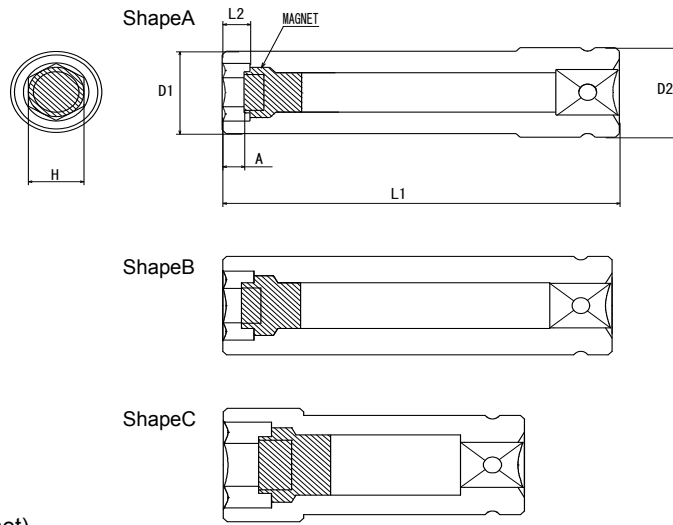

*We need A size for manufacturing sockets(Fixed Magnet).
Please jump to P95.

Code	Order No.	Shape	H (mm)	L2 (mm)	D1 (mm)	D2 (mm)	L1 (mm)	A (mm)	Weight (g)
*	OS-4B H10x35 MAG	A	10	7	16.5	25	35	within 7	*
*	OS-4B H10x75 MAG	A	10	5	16.5	25	75	within 5	*
*	OS-4B H10x100 MAG	A	10	5	16.5	25	100	within 5	*
*	OS-4B H12x35 MAG	A	12	6	20	25	35	within 6	*
*	OS-4B H12x52 MAG	A	12	6	20	25	52	within 6	*
*	OS-4B H12x75 MAG	A	12	6	20	25	75	within 6	*
*	OS-4B H12x100 MAG	A	12	6	20	25	100	within 6	*
*	OS-4B H13x35 MAG	A	13	8	21	24.5	35	within 8	*
*	OS-4B H13x75 MAG	A	13	6	21	25	75	within 6	*
*	OS-4B H13x100 MAG	A	13	6	21	25	100	within 6	*
*	OS-4B H14x52 MAG	A	14	7	22	25	52	within 7	*
*	OS-4B H14x100 MAG	A	14	7	23	25	100	within 7	*
*	OS-4B H17x38 MAG	B	17	11	26	26	38	within 11	*
*	OS-4B H17x52 MAG	A	17	8	26	28	52	within 8	*
*	OS-4B H17x75 MAG	A	17	11	26	28	75	within 11	*
*	OS-4B H17x100 MAG	A	17	8	26	28	100	within 8	*
*	OS-4B H19x40 MAG	B	19	11	28	28	40	within 11	*
*	OS-4B H19x52 MAG	C	19	10	30	28	52	within 10	*
*	OS-4B H19x100 MAG	C	19	10	30	28	100	within 10	*
*	OS-4B H21x75 MAG	C	21	12	32	28	75	within 12	*
*	OS-4B H22x43 MAG	C	22	14	30	28	43	within 14	*
*	OS-4B H22x75 MAG	C	22	13	32	28	75	within 13	*
*	OS-4B H24x43 MAG	C	24	14	32	28	43	within 14	*
*	OS-4B H24x75 MAG	C	24	15	36	28	75	within 15	*

Code * is custom made item.



Screw Driver Bits

OS-4 1/2"(Sq12.7mm drive)

Extension Sockets(Fixed Magnet)

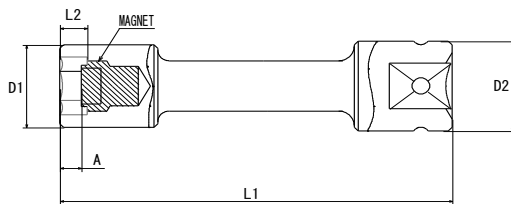
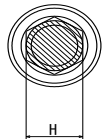

*We need A size for manufacturing sockets(Fixed Magnet).
Please jump to P95.

Code	Order No.	H (mm)	L2 (mm)	D1 (mm)	D2 (mm)	L1 (mm)	A (mm)	Weight (g)
*	OS-4B H10x100 EX MAG	10	5	16.5	25	100	within 5	*
*	OS-4B H10x150 EX MAG	10	5	16.5	25	150	within 5	*
*	OS-4B H10x200 EX MAG	10	5	16.5	25	200	within 5	*
*	OS-4B H10x250 EX MAG	10	5	16.5	25	250	within 5	*
*	OS-4B H12x100 EX MAG	12	6	20	25	100	within 6	*
*	OS-4B H12x150 EX MAG	12	6	20	25	150	within 6	*
*	OS-4B H12x200 EX MAG	12	6	20	25	200	within 6	*
*	OS-4B H12x250 EX MAG	12	6	20	25	250	within 6	*
*	OS-4B H13x100 EX MAG	13	6	21	25	100	within 6	*
*	OS-4B H13x150 EX MAG	13	6	21	25	150	within 6	*
*	OS-4B H13x200 EX MAG	13	6	21	25	200	within 6	*
*	OS-4B H13x250 EX MAG	13	6	21	25	250	within 6	*
*	OS-4B H14x100 EX MAG	14	7	23	25	100	within 7	*
*	OS-4B H14x150 EX MAG	14	7	23	25	150	within 7	*
*	OS-4B H14x200 EX MAG	14	7	23	25	200	within 7	*
*	OS-4B H14x250 EX MAG	14	7	23	25	250	within 7	*
*	OS-4B H17x100 EX MAG	17	8	26	28	100	within 8	*
*	OS-4B H17x150 EX MAG	17	8	26	28	150	within 8	*
*	OS-4B H17x200 EX MAG	17	8	26	28	200	within 8	*
*	OS-4B H17x250 EX MAG	17	8	26	28	250	within 8	*
*	OS-4B H19x100 EX MAG	19	10	30	28	100	within 10	*
*	OS-4B H19x150 EX MAG	19	10	30	28	150	within 10	*
*	OS-4B H19x200 EX MAG	19	10	30	28	200	within 10	*
*	OS-4B H19x250 EX MAG	19	10	30	28	250	within 10	*

Code * is custom made item.

Impact Sockets

Accessories

Point Size Selector

OS-4 1/2"(Sq12.7mm drive)

Socket(Slide Magnet)

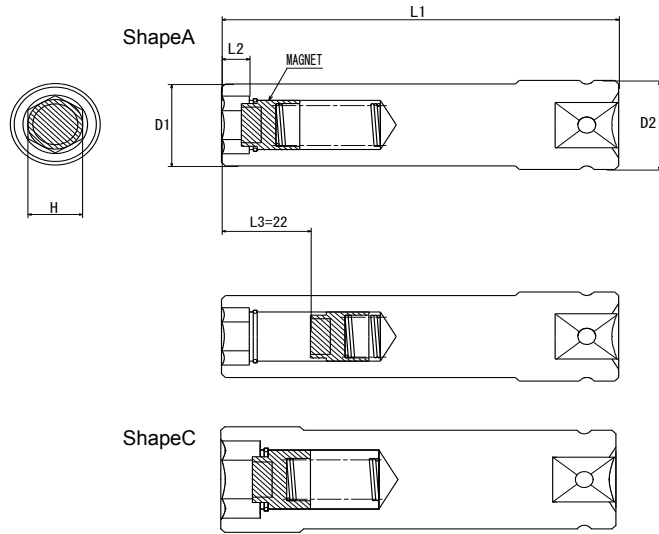

Code	Order No.	Shape	H (mm)	L2 (mm)	D1 (mm)	L3 (mm)	D2 (mm)	L1 (mm)	Weight (g)
*	OS-4B H10x75 SM	A	10	5	16.5	22	25	75	*
*	OS-4B H10x100 SM	A	10	5	16.5	22	25	100	*
*	OS-4B H12x75 SM	A	12	6	20	22	25	75	*
*	OS-4B H12x100 SM	A	12	6	20	22	25	100	*
*	OS-4B H13x75 SM	A	13	6	21	22	25	75	*
*	OS-4B H13x100 SM	A	13	6	21	22	25	100	*
*	OS-4B H14x75 SM	A	14	7	23	22	25	75	*
*	OS-4B H14x100 SM	A	14	7	23	22	25	100	*
*	OS-4B H17x75 SM	A	17	8	26	22	28	75	*
*	OS-4B H17x100 SM	A	17	8	26	22	28	100	*
*	OS-4B H19x75 SM	C	19	10	30	22	28	75	*
*	OS-4B H19x100 SM	C	19	10	30	22	28	100	*

Code * is custom made item.



Screw Driver Bits

OS-4 1/2"(Sq12.7mm drive)

Extension Sockets(Slide Magnet)

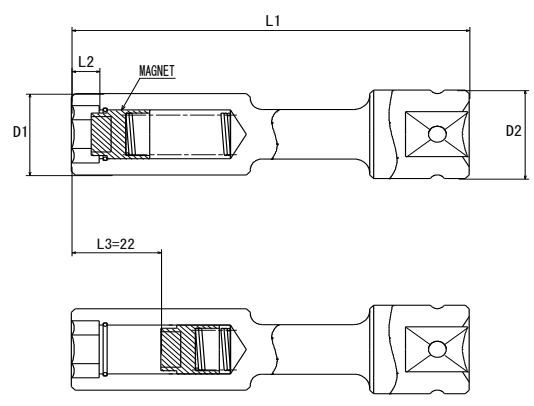
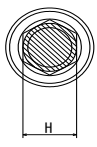

Impact Sockets

Accessories

Point Size Selector

Code	Order No.	H (mm)	L2 (mm)	D1 (mm)	L3 (mm)	D2 (mm)	L1 (mm)	Weight (g)
*	OS-4B H10x100 EX SM	10	5	16.5	22	25	100	*
*	OS-4B H10x150 EX SM	10	5	16.5	22	25	150	*
*	OS-4B H10x200 EX SM	10	5	16.5	22	25	200	*
*	OS-4B H12x100 EX SM	12	6	20	22	25	100	*
*	OS-4B H12x150 EX SM	12	6	20	22	25	150	*
*	OS-4B H12x200 EX SM	12	6	20	22	25	200	*
*	OS-4B H13x100 EX SM	13	6	21	22	25	100	*
*	OS-4B H13x150 EX SM	13	6	21	22	25	150	*
*	OS-4B H13x200 EX SM	13	6	21	22	25	200	*
*	OS-4B H14x100 EX SM	14	7	23	22	25	100	*
*	OS-4B H14x150 EX SM	14	7	23	22	25	150	*
*	OS-4B H14x200 EX SM	14	7	23	22	25	200	*
*	OS-4B H17x100 EX SM	17	8	26	22	28	100	*
*	OS-4B H17x150 EX SM	17	8	26	22	28	150	*
*	OS-4B H17x200 EX SM	17	8	26	22	28	200	*
*	OS-4B H19x100 EX SM	19	10	30	22	28	100	*
*	OS-4B H19x150 EX SM	19	10	30	22	28	150	*
*	OS-4B H19x200 EX SM	19	10	30	22	28	200	*

Code * is custom made item.

OS-4 1/2"(Sq12.7mm drive)

Socket(Magnet Ring)

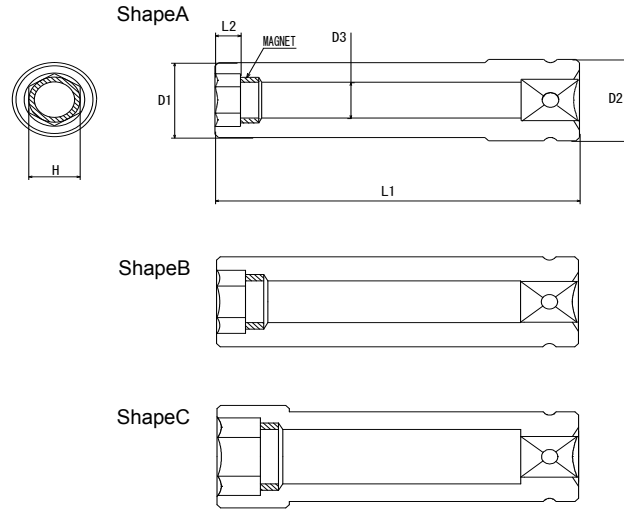

Code	Order No.	Shape	H (mm)	L2 (mm)	D1 (mm)	D3 (mm)	D2 (mm)	L1 (mm)	Weight (g)
*	OS-4B H10x35 MR	A	10	7	16.5	8	25	35	*
*	OS-4B H10x75 DE MR	A	10	5	16.5	7	25	75	*
*	OS-4B H10x100 DE MR	A	10	5	16.5	7	25	100	*
*	OS-4B H12x35 MR	A	12	6	20	9	25	35	*
*	OS-4B H12x52 MR	A	12	6	20	9	25	52	*
*	OS-4B H12x75 DE MR	A	12	6	20	9	25	75	*
*	OS-4B H12x100 DE MR	A	12	6	20	9	25	100	*
*	OS-4B H13x35 MR	A	13	8	21	11	24.5	35	*
*	OS-4B H13x75 DE MR	A	13	6	21	10	25	75	*
*	OS-4B H13x100 DE MR	A	13	6	21	10	25	100	*
*	OS-4B H14x52 MR	A	14	7	22	11	25	52	*
*	OS-4B H14x100 DE MR	A	14	7	23	11	25	100	*
*	OS-4B H17x38 MR	B	17	11	26	13	26	38	*
*	OS-4B H17x52 MR	A	17	8	26	13	28	52	*
*	OS-4B H17x75 DE MR	A	17	11	26	13	28	75	*
*	OS-4B H17x100 DE MR	A	17	8	26	13	28	100	*
*	OS-4B H19x40 MR	B	19	11	28	17	28	40	*
*	OS-4B H19x52 MR	C	19	10	30	17	28	52	*
*	OS-4B H19x100 DE MR	C	19	10	30	15	28	100	*
*	OS-4B H21x75 DE MR	C	21	12	32	17	28	75	*
*	OS-4B H22x43 MR	C	22	14	30	18	28	43	*
*	OS-4B H22x75 DE MR	C	22	13	32	19	28	75	*
*	OS-4B H24x43 MR	C	24	14	32	20	28	43	*
*	OS-4B H24x75 DE MR	C	24	15	36	20	28	75	*

Code * is custom made item.

*The magnetice force doesn't work well depeding on the depth of L2 if you are use the bolt or nut with flange. Please inquire or order us about these items after confirming specification.

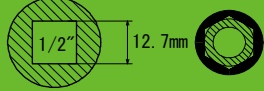

Screw Driver Bits

OS-4 1/2"(Sq12.7mm drive)

Extension Sockets(Magnet Ring)

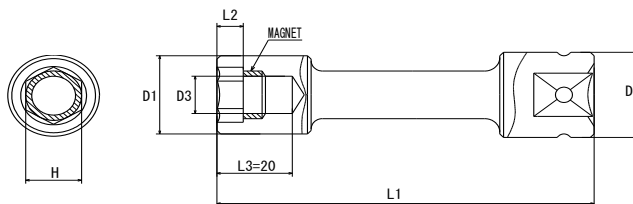

Impact Sockets

Accessories

Point Size Selector

Code	Order No.	H (mm)	L2 (mm)	D1 (mm)	D3 (mm)	L3 (mm)	D2 (mm)	L1 (mm)	Weight (g)
*	OS-4B H10x100 EX MR	10	5	16.5	7	20	25	100	*
*	OS-4B H10x150 EX MR	10	5	16.5	7	20	25	150	*
*	OS-4B H10x200 EX MR	10	5	16.5	7	20	25	200	*
*	OS-4B H10x250 EX MR	10	5	16.5	7	20	25	250	*
*	OS-4B H12x100 EX MR	12	6	20	9	20	25	100	*
*	OS-4B H12x150 EX MR	12	6	20	9	20	25	150	*
*	OS-4B H12x200 EX MR	12	6	20	9	20	25	200	*
*	OS-4B H12x250 EX MR	12	6	20	9	20	25	250	*
*	OS-4B H13x100 EX MR	13	6	21	10	20	25	100	*
*	OS-4B H13x150 EX MR	13	6	21	10	20	25	150	*
*	OS-4B H13x200 EX MR	13	6	21	10	20	25	200	*
*	OS-4B H13x250 EX MR	13	6	21	10	20	25	250	*
*	OS-4B H14x100 EX MR	14	7	23	11	20	25	100	*
*	OS-4B H14x150 EX MR	14	7	23	11	20	25	150	*
*	OS-4B H14x200 EX MR	14	7	23	11	20	25	200	*
*	OS-4B H14x250 EX MR	14	7	23	11	20	25	250	*
*	OS-4B H17x100 EX MR	17	8	26	13	20	28	100	*
*	OS-4B H17x150 EX MR	17	8	26	13	20	28	150	*
*	OS-4B H17x200 EX MR	17	8	26	13	20	28	200	*
*	OS-4B H17x250 EX MR	17	8	26	13	20	28	250	*
*	OS-4B H19x100 EX MR	19	10	30	15	20	28	100	*
*	OS-4B H19x150 EX MR	19	10	30	15	20	28	150	*
*	OS-4B H19x200 EX MR	19	10	30	15	20	28	200	*
*	OS-4B H19x250 EX MR	19	10	30	15	20	28	250	*

Code * is custom made item.

OS-4 1/2"(Sq12.7mm drive)

Hexagon

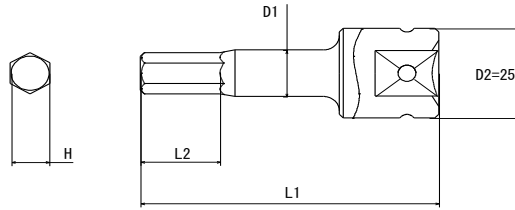

Code	Order No.	H (mm)	L2 (mm)	D1 (mm)	D2 (mm)	L1 (mm)	Weight (g)
*	OS-4X H5x50	5	10	10	25	50	*
00010664	OS-4X H5x75	5	15	10	25	75	92
00010665	OS-4X H5x100	5	15	10	25	100	107
*	OS-4X H6x50	6	10	10	25	50	*
00010666	OS-4X H6x75	6	20	10	25	75	92
00010667	OS-4X H6x100	6	20	10	25	100	108
*	OS-4X H8x50	8	15	10	25	50	*
00010668	OS-4X H8x75	8	20	10	25	75	97
00010669	OS-4X H8x100	8	20	10	25	100	114
*	OS-4X H10x50	10	15	13	25	50	*
00010670	OS-4X H10x75	10	20	13	25	75	114
00010671	OS-4X H10x100	10	20	13	25	100	140
*	OS-4X H12x50	12	15	14	25	50	*
00010672	OS-4X H12x75	12	20	14	25	75	125
00010673	OS-4X H12x100	12	20	14	25	100	155
*	OS-4X H14x50	14	15	16	25	50	*
00010674	OS-4X H14x75	14	20	16	25	75	143
00010675	OS-4X H14x100	14	20	16	25	100	182
*	OS-4X H17x50	17	15	20	25	50	*
00010676	OS-4X H17x75	17	20	20	25	75	184
00010677	OS-4X H17x100	17	20	20	25	100	246

Code * is custom made item.

External Hex-wave

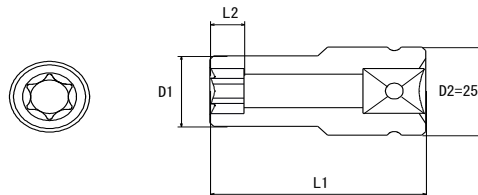

Code	Order No.	Point Size	L2 (mm)	D1 (mm)	D2 (mm)	L1 (mm)	Weight (g)
*	OS-4E E10x55	E10	7	16	25	55	*
*	OS-4E E10x75	E10	7	16	25	75	*
*	OS-4E E12x55	E12	8	18	25	55	*
*	OS-4E E12x75	E12	8	18	25	75	*
*	OS-4E E14x55	E14	8	20	25	55	*
*	OS-4E E14x75	E14	8	20	25	75	*
*	OS-4E E16x55	E16	10	20	25	55	*
*	OS-4E E16x75	E16	10	20	25	75	*

Code * is custom made item.

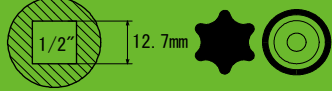

Screw Driver Bits

OS-4 1/2"(Sq12.7mm drive)

Hex-wave

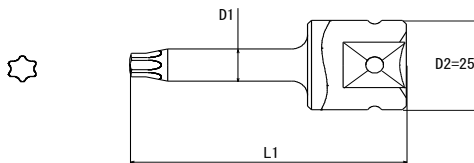

Impact Sockets

Code	Order No.	Point Size	D1 (mm)	D2 (mm)	L1 (mm)	Weight (g)
*	OS-4T T30x50	T30	9	25	50	*
00010678	OS-4T T30x70	T30	9	25	70	88
00010679	OS-4T T30x100	T30	9	25	100	103
*	OS-4T T40x50	T40	9	25	50	*
00010680	OS-4T T40x70	T40	9	25	70	88
00010681	OS-4T T40x100	T40	9	25	100	103
*	OS-4T T45x50	T45	9	25	50	*
00013425	OS-4T T45x70	T45	9	25	70	89
00013426	OS-4T T45x100	T45	9	25	100	104
*	OS-4T T50x50	T50	9	25	50	*
00010682	OS-4T T50x70	T50	9	25	70	91
00010683	OS-4T T50x100	T50	9	25	100	106
*	OS-4T T55x50	T55	12	25	50	*
00010684	OS-4T T55x70	T55	12	25	70	109
00010685	OS-4T T55x100	T55	12	25	100	134
*	OS-4T T60x50	T60	16	25	50	*
*	OS-4T T60x70	T60	16	25	70	*
*	OS-4T T60x100	T60	16	25	100	*

Code * is custom made item.

Accessories

Point Size Selector

Sockets for Stud Bolt

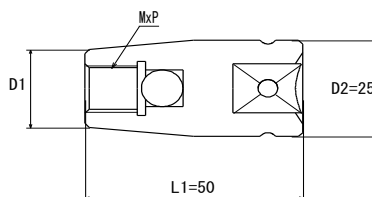

Code	Order No.	Screw Size (mm)	D1 (mm)	D2 (mm)	L1 (mm)	Weight (g)
*	OS-4SB (M6x1.0P)x50	M6xP1.0	13	25	50	*
*	OS-4SB (M8x1.25P)x50	M8xP1.25	15	25	50	*
*	OS-4SB (M10x1.25P)x50	M10xP1.25	16	25	50	*
*	OS-4SB (M10x1.5P)x50	M10xP1.5	16	25	50	*
*	OS-4SB (M12x1.25P)x50	M12xP1.25	20	25	50	*
*	OS-4SB (M12x1.5P)x50	M12xP1.5	20	25	50	*
*	OS-4SB (M12x1.75P)x50	M12xP1.75	20	25	50	*
*	OS-4SB (M14x1.5P)x50	M14xP1.5	22	25	50	*
*	OS-4SB (M14x2.0P)x50	M14xP2.0	22	25	50	*

Code * is custom made item.

OS-4 1/2"(Sq12.7mm drive)

Adapter(Pin Type)

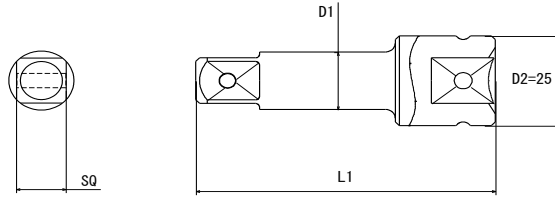

Code	Order No.	SQ (mm)	Type of Lock	D1 (mm)	D2 (mm)	L1 (mm)	Weight (g)
00010686	OS-4AD SQ12.7x75	12.7	PIN	16	25	75	140
00010687	OS-4AD SQ12.7x125	12.7	PIN	16	25	125	221
00010688	OS-4AD SQ12.7x150	12.7	PIN	16	25	150	260
00010689	OS-4AD SQ12.7x200	12.7	PIN	16	25	200	339
00010690	OS-4AD SQ12.7x250	12.7	PIN	16	25	250	418
00010691	OS-4AD SQ12.7x300	12.7	PIN	16	25	300	497
00010692	OS-4AD SQ9.52x37	9.52	PIN	—	25	37	70



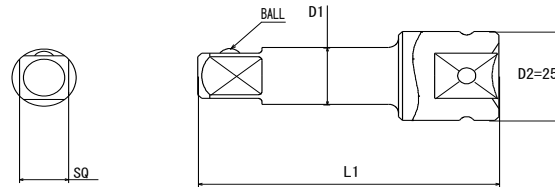







Adapter(Ball Type)



Code	Order No.	SQ (mm)	Type of Lock	D1 (mm)	D2 (mm)	L1 (mm)	Weight (g)
00010693	OS-4AD SQ12.7x75 BALL	12.7	BALL	16	25	75	140
00010694	OS-4AD SQ12.7x125 BALL	12.7	BALL	16	25	125	221
00010695	OS-4AD SQ12.7x150 BALL	12.7	BALL	16	25	150	260
00010696	OS-4AD SQ12.7x200 BALL	12.7	BALL	16	25	200	339
00010697	OS-4AD SQ12.7x250 BALL	12.7	BALL	16	25	250	418
00010698	OS-4AD SQ12.7x300 BALL	12.7	BALL	16	25	300	497
00010699	OS-4AD SQ9.52x37 BALL	9.52	BALL	—	25	37	70

Screw Driver Bits

Point Style

- | | | | | | |
|---|-----------------|---|-------------------|---|---------|
|  | Nut Setter(6P) |  | Hexagon |  | Adapter |
|  | Nut Setter(12P) |  | Hex-wave |  | XZN |
|  | Nut Setter(SF) |  | External Hex-wave | | |
|  | Nut Setter(FL) |  | For Stud Bolts | | |

Impact Sockets

Drive Size

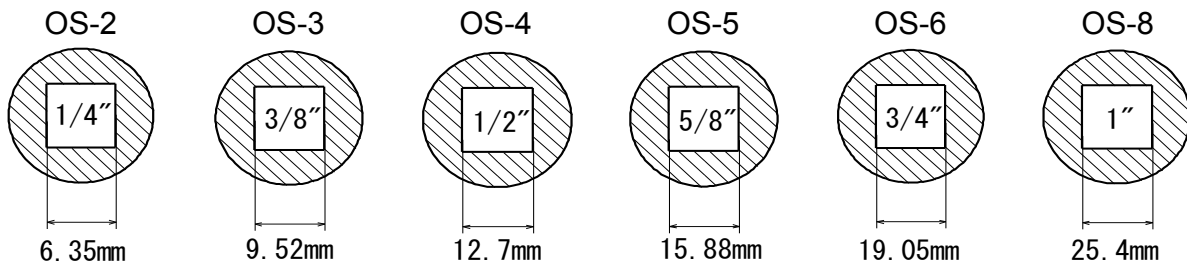

Accessories

Magnet

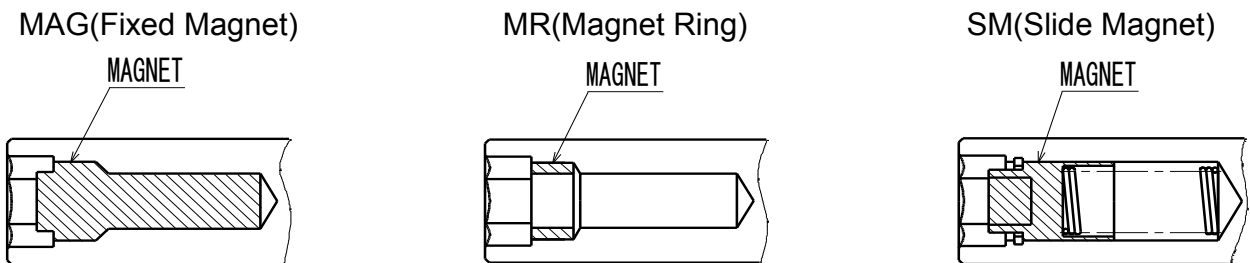

Point Size Selector

MCNC(Nylon Cover)

For preventing the work from getting damage on work.

*Color would be blue or white.

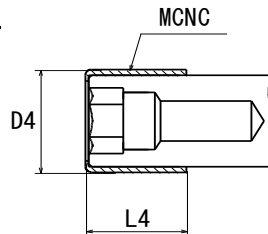

Anti Vibration

For improving torque transmission.

For reducing vibration.

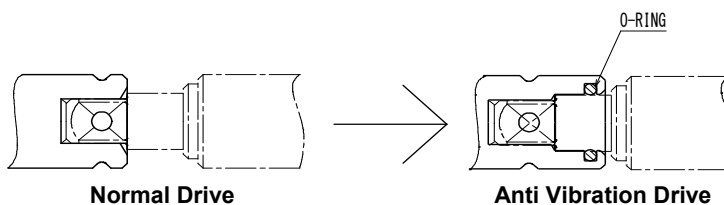

*We need model No.of tool for manufacturing.

Company : _____
 Address : _____
 Quantity(Pcs) : _____

Person in charge : _____
 E-mail : _____
 Tel : _____

Nut Setter

<input type="checkbox"/> 6P		<input type="checkbox"/> DE						Drive Size <input type="checkbox"/> OS-2 (1/4"=Sq 6.35mm) <input type="checkbox"/> OS-3 (3/8"=Sq 9.52mm) <input type="checkbox"/> OS-4 (1/2"=Sq 12.7mm) <input type="checkbox"/> OS-5 (5/8"=Sq 15.88mm) <input type="checkbox"/> OS-6 (3/4"=Sq 19.05mm) <input type="checkbox"/> OS-8 (1"=Sq 25.4mm)	
<input type="checkbox"/> 12P		<input type="checkbox"/> EX							
<input type="checkbox"/> SF		<input type="checkbox"/> UN							
<input type="checkbox"/> FL							Extra Request <input type="checkbox"/> MCNC <input type="checkbox"/> Anti Vibration Model No. of tool : _____ <input type="checkbox"/> MAG(Fixed Magnet) *Please refer to P95(A size). <input type="checkbox"/> MR(Magnet Ring) <input type="checkbox"/> SM(Slide Magnet)		
	H (mm)	L2 (mm)	D1 (mm)	D3 (mm)	L3 (mm)	D2 (mm)	L1 (mm)	D4(MCNC) (mm)	L4(MCNC) (mm)

*Please fill out blanks, other dimensions which there is no instruction will be our specification.

...A size...

We need A size for manufacturing Nut setter and External Hex-wave with Fixed Magnet.

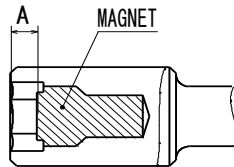

Please fill out blanks.

We will set the best A size based on their information.

*There are cases we request sample bolts.

Bolts shape No.	B1 (mm)	B2 (mm)	B3 (mm)

List of Bolts Shape

1	2	3
4	5	6

Company : _____
 Address : _____
 Quantity(Pcs) : _____

Person in charge : _____
 E-mail : _____
 Tel : _____

Screw Driver Bits

Impact Sockets

Accessories

Point Size Selector

Hexagon

					Drive Size <input type="checkbox"/> OS-5 (5/8"=Sq15.88mm) <input type="checkbox"/> OS-2 (1/4"=Sq6.35mm) <input type="checkbox"/> OS-6 (3/4"=Sq19.05mm) <input type="checkbox"/> OS-3 (3/8"=Sq9.52mm) <input type="checkbox"/> OS-8 (1"=Sq25.4mm) <input type="checkbox"/> OS-4 (1/2"=Sq12.7mm)
H (mm)	L2 (mm)	D1 (mm)	D2 (mm)	L1 (mm)	Extra Request <input type="checkbox"/> Anti Vibration Model No.of tool :

*Please fill out blanks, other dimensions which there is no instruction will be our specification.

Hex-wave

					Drive Size <input type="checkbox"/> OS-5 (5/8"=Sq15.88mm) <input type="checkbox"/> OS-2 (1/4"=Sq6.35mm) <input type="checkbox"/> OS-6 (3/4"=Sq19.05mm) <input type="checkbox"/> OS-3 (3/8"=Sq9.52mm) <input type="checkbox"/> OS-8 (1"=Sq25.4mm) <input type="checkbox"/> OS-4 (1/2"=Sq12.7mm)
Point Size	D1 (mm)	D2 (mm)	L1 (mm)	Extra Request <input type="checkbox"/> Anti Vibration Model No.of tool :	

*Please fill out blanks, other dimensions which there is no instruction will be our specification.

External Hex-wave

<input type="checkbox"/> DE 		<input type="checkbox"/> EX 			Drive Size <input type="checkbox"/> OS-2 (1/4"=Sq 6.35mm) <input type="checkbox"/> OS-3 (3/8"=Sq 9.52mm) <input type="checkbox"/> OS-4 (1/2"=Sq 12.7mm) <input type="checkbox"/> OS-5 (5/8"=Sq 15.88mm) <input type="checkbox"/> OS-6 (3/4"=Sq 19.05mm) <input type="checkbox"/> OS-8 (1"=Sq 25.4mm)		
Point Size	L2 (mm)	D1 (mm)	D2 (mm)	L1 (mm)	D4(MCNC) (mm)	L4(MCNC) (mm)	Extra Request <input type="checkbox"/> MAG <input type="checkbox"/> MCNC *Please refer to P95(A size). <input type="checkbox"/> Anti Vibration Model No. of tool :

*Please fill out blanks, other dimensions which there is no instruction will be our specification.

Adapter

					Drive Size <input type="checkbox"/> OS-5 (5/8"=Sq15.88mm) <input type="checkbox"/> OS-2 (1/4"=Sq6.35mm) <input type="checkbox"/> OS-6 (3/4"=Sq19.05mm) <input type="checkbox"/> OS-3 (3/8"=Sq9.52mm) <input type="checkbox"/> OS-8 (1"=Sq25.4mm) <input type="checkbox"/> OS-4 (1/2"=Sq12.7mm)	
<input type="checkbox"/> Ball lock type 	<input type="checkbox"/> Pin lock type 	SQ (mm)	D1 (mm)	D2 (mm)	L1 (mm)	Extra Request <input type="checkbox"/> Anti Vibration Model No.of tool :

*Please fill out blanks, other dimensions which there is no instruction will be our specification.

