

Directional control - SM series Solenoid valve

Solenoid valve - SM5000 , SM7000 , SM9000

CHELIC PNEUMATIC

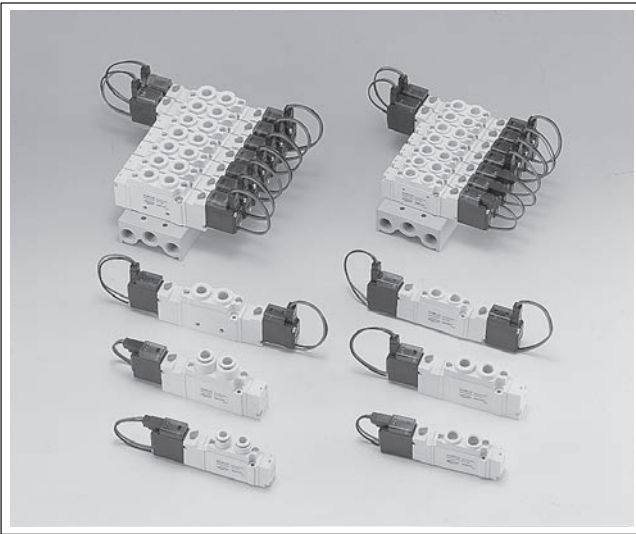

Provide CAD external dimension.

Small size, big flow rate!
high speed , react quickly ; (Under 10 ms)
with indicator light and voltage protection circuit ;
air hole can be changed and be added connector.

Solenoid valve single coil ----- **SM - 5000 series** --- Rc1/8" , Ø4 , Ø6 , Ø8 ----- **P.2-1.3**
(5 ports 2 positions)

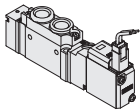

SM - 7000 series --- Rc1/8" , 1/4" , Ø6 , Ø8 , Ø10 ----- **P.2-1.10**

SM - 9000 series --- Rc1/4" , 3/8" , Ø8 , Ø10 , Ø12 ----- **P.2-1.17**

Solenoid valve double coils --- **SM - 5000 series** --- Rc1/8" , Ø4 , Ø6 , Ø8 ----- **P.2-1.3**
(5 ports 2 positions)

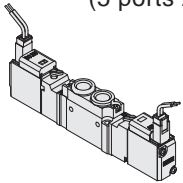

SM - 7000 series --- Rc1/8" , 1/4" , Ø6 , Ø8 , Ø10 ----- **P.2-1.10**

SM - 9000 series --- Rc1/4" , 3/8" , Ø8 , Ø10 , Ø12 ----- **P.2-1.17**

Solenoid valve double coils --- **SM - 5000 series** --- Rc1/8" , Ø4 , Ø6 , Ø8 ----- **P.2-1.5**
(5 ports 3 positions)

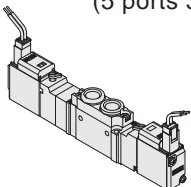

SM - 7000 series --- Rc1/8" , 1/4" , Ø6 , Ø8 , Ø10 ----- **P.2-1.12**

SM - 9000 series --- Rc1/4" , 3/8" , Ø8 , Ø10 , Ø12 ----- **P.2-1.18**

SM
Solenoid Valve

SMB
Solenoid Valve

SMU
Solenoid Valve

SMUB
Solenoid Valve

SR
Solenoid Valve

SRB
Solenoid Valve

SRU
Solenoid Valve

SRUB
Solenoid Valve

SRK
Solenoid Valve

SK
Solenoid Valve

SNK
Solenoid Valve

SKU
Solenoid Valve

SV
Solenoid Valve

SN
Solenoid Valve

SV310
Solenoid Valve

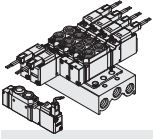

Safety notice / Caution for application

SM series - Solenoid valve

CHELIC PNEUMATIC



Please read the safety notice carefully before using and pay attention to the safety caution for this series of products.

Operation and Instruction for manual for manual button

- Press down manual button to rotate the switching position so that solenoid valve on the lock status.

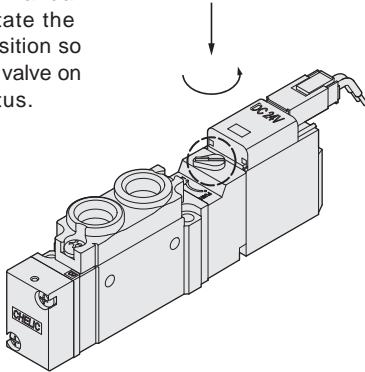

- The purpose of pressing the manual button is to provide manual test or test run adjustment. It is not for normal use.

- Must be check the lock status if it has been lifted. Manually button must be at **Push** position that it can be normal used for electronic control.

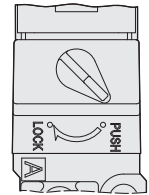

AV220V Solenoid Coil

Warning : Electrification, High temperature and Instruction

- SM solenoid coil with built-in rectifying circuit and electrified indicator light , with specification of AC220V , the built-in circuit is heated when electrified with high surface temperature (It is within safety range , Don't worry) , Please avoid touching it.

Sage surge voltage protection circuit

| | |
|---------|--------------------|
| DC 12V | Below ± 0.1 mA |
| DC 24V | Below ± 0.1 mA |
| AC 110V | Below ± 0.1 mA |
| AC 220V | Below ± 0.1 mA |

Method and description of the selection of terminal board

- (1) Direction (Horizontal& Vertical)
- (2) Terminal and Wire (Pressed)

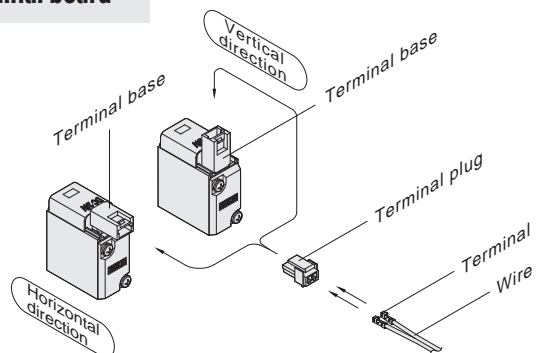

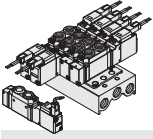

Safety notice / Caution for application

SM series - Solenoid valve

CHELIC PNEUMATIC

(3) Terminal and Press chain (Device positioning)

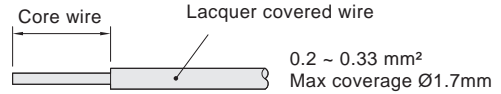
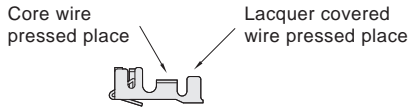

(4) Press chain and Socket (Pressed and Pulled)

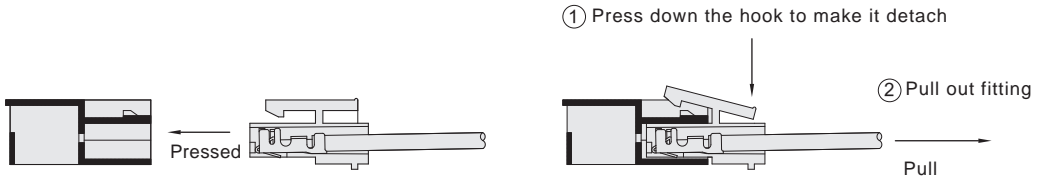

● Note : It will cause plug and coil damaged because of pulling out fitting by wrong way.

Selection and use of the through hole connection plate

● Select “ thread type connection plate ”, may select various connector in discretion and fixed by screw thread.

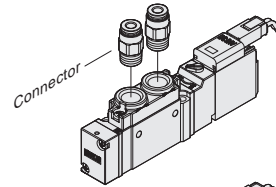

● Select “ connection plate with connector ”, first select the size of pipe diameter ; just insert the pipe into position while assembling , need no connector tightening.

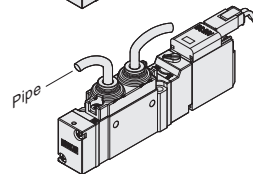

● Selection specification of the through hole connection plate :

| Model | Thread type | | | Piping of connector type | | | | |
|--------|-------------|-----|-----|--------------------------|----|----|-----|-----|
| | 1/8 | 1/4 | 3/8 | Ø4 | Ø6 | Ø8 | Ø10 | Ø12 |
| SM5000 | ● | — | — | ● | ● | ● | — | — |
| SM7000 | ● | ● | — | — | ● | ● | ● | — |
| SM9000 | — | ● | ● | — | — | ● | ● | ● |

🔍 Note : The solenoid valve with connector that the height is lower and easy to install.

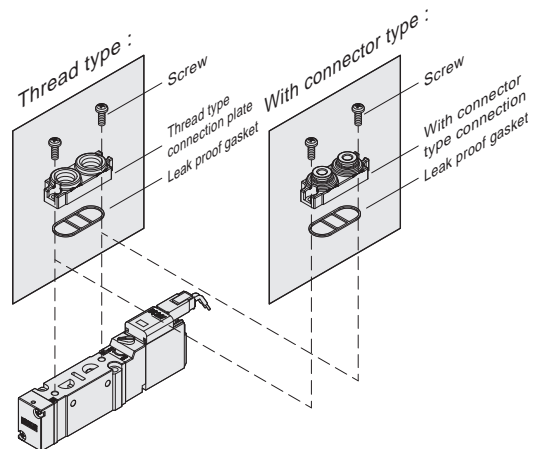

Safety notice

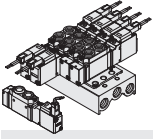

Safety notice / Caution for application

SM series - Solenoid valve

CHELIC PNEUMATIC



Please read the safety notice carefully before using and pay attention to the safety caution for this series of products.

Safety notice

Attention for connecting pipe application

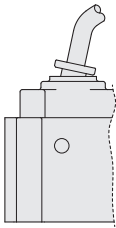

(X)

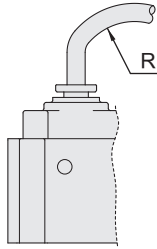

(O)

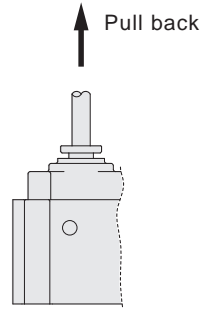

- The pressed piece should not skew at bent portion which will tend to leakage and rupture.
- According to the pipe diameter as illustrated to prevent too small radius resulting to leakage and poor flow of the fluid.

- There are two stages tighter feeling while inserting the pipe, this in normal, the pipe must be inserted to very end.
- Pull back the pipe while finish inserting to make sure tightness.

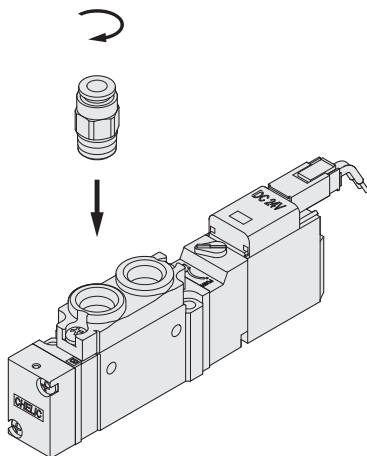

- Please secure the solenoid valve before inserting the connector.
- Never press the solenoid valve when tightening which cause damage at the joint.

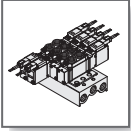

SM series - Solenoid valve

Flow rate and Applicable cylinder

CHELIC PNEUMATIC

Applicable cylinder (Reference)

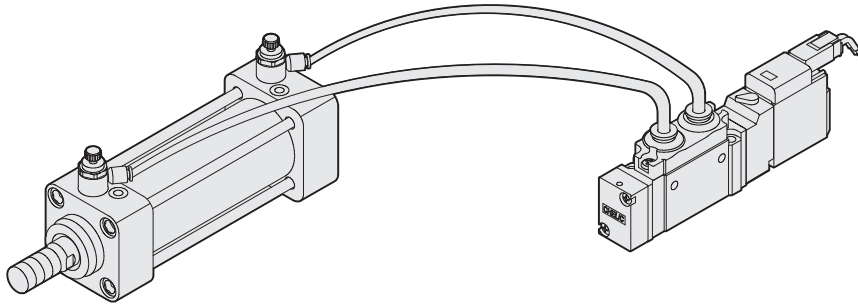

● Max. driving speed of the cylinder (Length of piping : 1mm , diameter Ø8)

| Model | CV Value | Cylinder speed mm/s | SDA,DB,FDA series | | | | | | DMB,DN,DU series | | | | |
|--------|----------|------------------------|-------------------|-----|-----|-----|-----|-----|------------------|-----|-----|-----|------|
| | | | Ø12 | Ø16 | Ø20 | Ø25 | Ø32 | Ø40 | Ø40 | Ø50 | Ø63 | Ø80 | Ø100 |
| SM5000 | 0.5 | 150 | | | | | | | | | | | |
| | | 300 | | | | | | | | | | | |
| | | 450 | | | | | ● | ● | ● | | | | |
| | | 600 | | | | ● | | | | | | | |
| | | 750 | | | ● | | | | | | | | |
| | | 900 | ● | ● | | | | | | | | | |
| SM7000 | 0.9 | 150 | | | | | | | | | | | ● |
| | | 300 | | | | | | | | | | | |
| | | 450 | | | | | | ● | | | | | |
| | | 600 | | | | | ● | | | ● | | | |
| | | 750 | | | | ● | | | ● | | | | |
| | | 900 | | | ● | | | | | | | | |
| SM9000 | 1.7 | 150 | | | | | | | | | | | ● |
| | | 300 | | | | | | | | ● | | ● | |
| | | 450 | | | | | | ● | | ● | | | |
| | | 600 | | | ● | ● | ● | | | | | | |
| | | 750 | | | | | | | | | | | |
| | | 900 | | | | | | | | | | | |

- SM**
Solenoid Valve
- SMB**
Solenoid Valve
- SMU**
Solenoid Valve
- SMUB**
Solenoid Valve
- SR**
Solenoid Valve
- SRB**
Solenoid Valve
- SRU**
Solenoid Valve
- SRUB**
Solenoid Valve
- SRK**
Solenoid Valve
- SK**
Solenoid Valve
- SNK**
Solenoid Valve
- SKU**
Solenoid Valve
- SV**
Solenoid Valve
- SN**
Solenoid Valve
- SV310**
Solenoid Valve

A large grid of graph paper for taking notes, consisting of 20 columns and 30 rows of small squares.

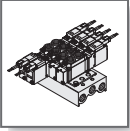

SM 5000、7000、9000 series - Solenoid valve

Operating specification and Order expression

CHELIC PNEUMATIC

Internal structure

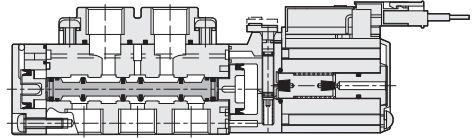
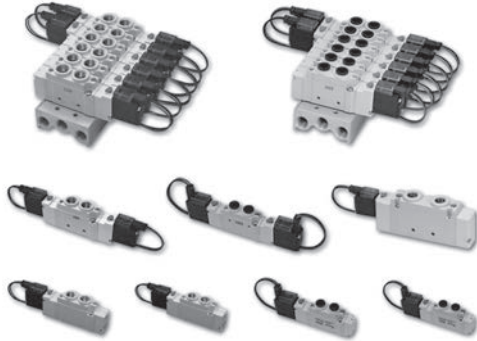

SM
Solenoid Valve

SMB
Solenoid Valve

SMU
Solenoid Valve

SMUB
Solenoid Valve

SR
Solenoid Valve

SRB
Solenoid Valve

SRU
Solenoid Valve

SRUB
Solenoid Valve

SRK
Solenoid Valve

SK
Solenoid Valve

SNK
Solenoid Valve

SKU
Solenoid Valve

SV
Solenoid Valve

SN
Solenoid Valve

SV310
Solenoid Valve

Specification

| Item | Model | SM5000 | | SM7000 | | SM9000 | |
|-------------------------------------|---------------------------|------------------------|------------------------|---|------------------------|------------------------|------------------------|
| | | | | | | | |
| Fluid | | Air | | | | | |
| Pressure range | kgf/cm ² (Kpa) | 1.5 ~ 7 (150 ~ 700) | | | | | |
| Operating ambient temperature range | °C | 0 ~ 50 | | | | | |
| Operating method | | Pilot operated | | | | | |
| Number of position ports | | 5 ports 2 positions | 5 ports 3 positions | 5 ports 2 positions | 5 ports 3 positions | 5 ports 2 positions | 5 ports 3 positions |
| Valve functions | | Normal closed | | | | | |
| Orifice | mm ² (CV) | 9 (0.5) | | 16.2 (0.9) | | 30.6 (1.7) | |
| Manual button | | Push and lock | | | | | |
| Connection port | | Rc 1/8, Ø4, Ø6, Ø8 | | Rc1/8, Rc 1/4, Rc 3/8, Ø6, Ø8, Ø10, Ø12 | | | |
| Lubrication | | Lubrication free type | | | | | |

How to order

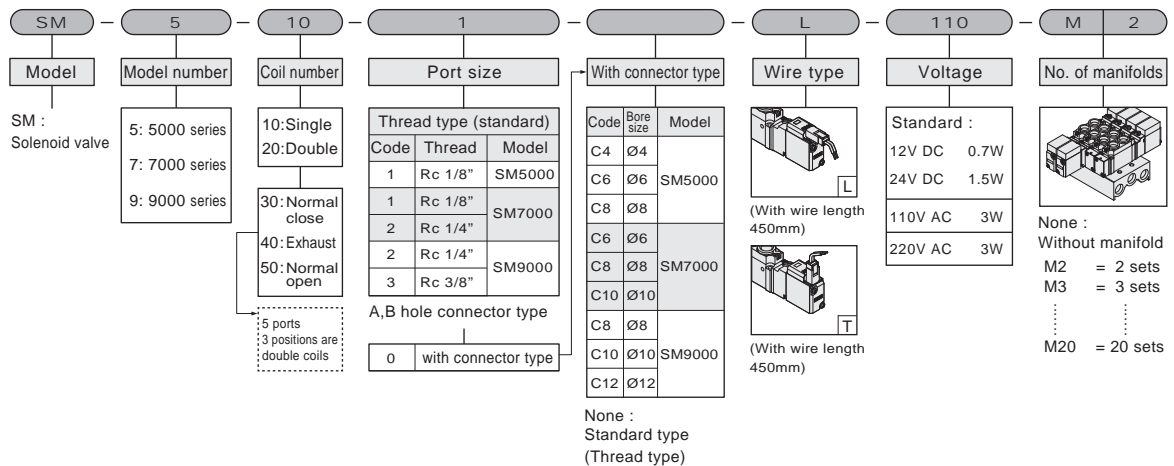

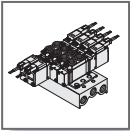

SM 5000 、 7000 、 9000 series - Solenoid valve

Components and Material list

CHELIC PNEUMATIC

● Single 5 ports 2 positions

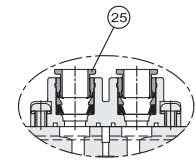
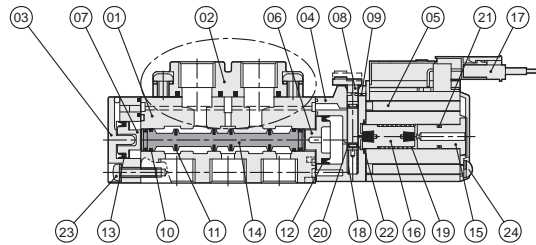

- With connector type

● Double 5 ports 2 positions

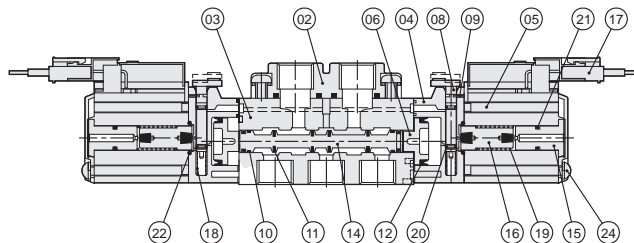
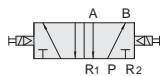

● Double 5 ports 3 positions

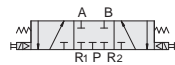

(Normal close N.C.)



(Exhaust N.F.)

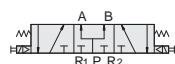

(Normal open N.O.)

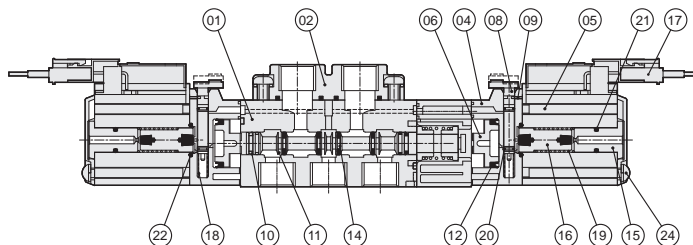

● Components and Material list

| No. | Item | Material | No. | Item | Material |
|-----|------------|----------------|-----|------------|-----------------|
| 01 | Body | Aluminum alloy | 14 | Shaft | Aluminum alloy |
| 02 | Top cover | Aluminum alloy | 15 | Iron cores | Stainless steel |
| 03 | End cover | Resin | 16 | Iron cores | Stainless steel |
| 04 | Holder | Resin | 17 | Wire plug | Resin |
| 05 | Coil | — | 18 | Spring | Stainless steel |
| 06 | Piston | POM | 19 | Spring | Stainless steel |
| 07 | Piston | POM | 20 | O-ring | NBR |
| 08 | Shaft | POM | 21 | O-ring | NBR |
| 09 | Iron sheet | Iron | 22 | O-ring | NBR |
| 10 | Packing | NBR | 23 | Screw | Alloy steel |
| 11 | Packing | NBR | 24 | Screw | Alloy steel |
| 12 | Packing | NBR | 25 | Connector | Plastic |
| 13 | Packing | NBR | | | |

Note : The main body be treated with painting.

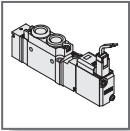

SM series Solenoid valve - SM 5000

External dimension / Standard

CHELIC PNEUMATIC

SM 5101

Single 5 ports 2 positions

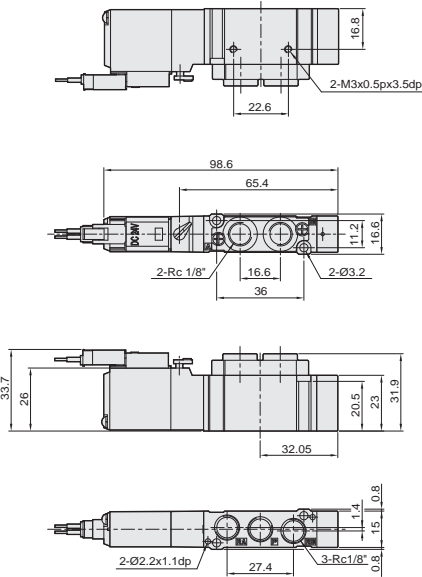

L wire type - L

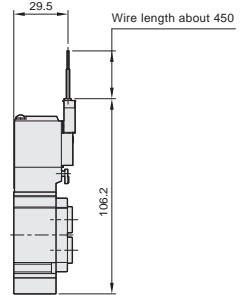

T wire type - T

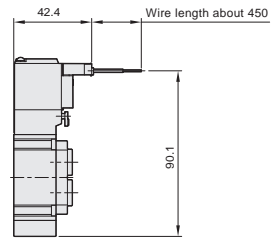

SM 5201

Double 5 ports 2 positions

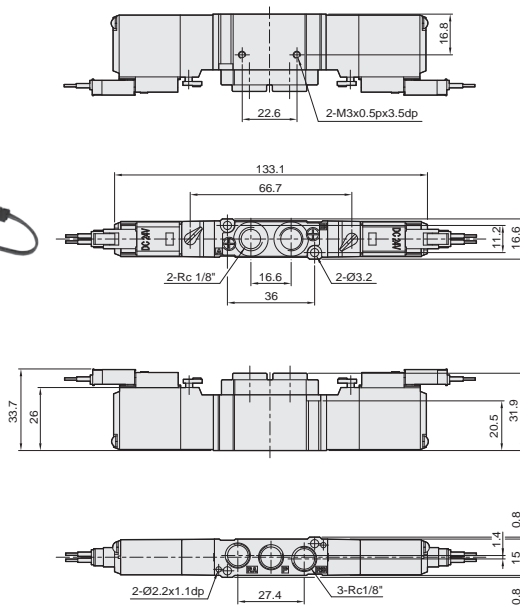

L wire type - L

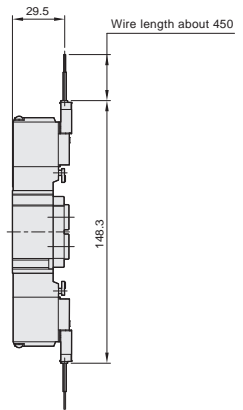

T wire type - T

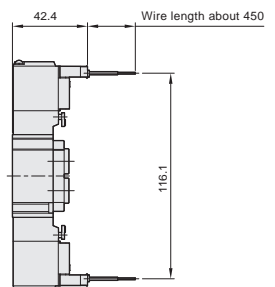

SM
Solenoid Valve

SMB
Solenoid Valve

SMU
Solenoid Valve

SMUB
Solenoid Valve

SR
Solenoid Valve

SRB
Solenoid Valve

SRU
Solenoid Valve

SRUB
Solenoid Valve

SRK
Solenoid Valve

SK
Solenoid Valve

SNK
Solenoid Valve

SKU
Solenoid Valve

SV
Solenoid Valve

SN
Solenoid Valve

SV310
Solenoid Valve

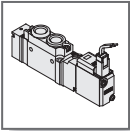

SM series Solenoid valve - SM 5000

External dimension / Standard / 3 ports 2 positions

CHELIC PNEUMATIC

SM 5101 - TA

Single 3 ports 2 positions

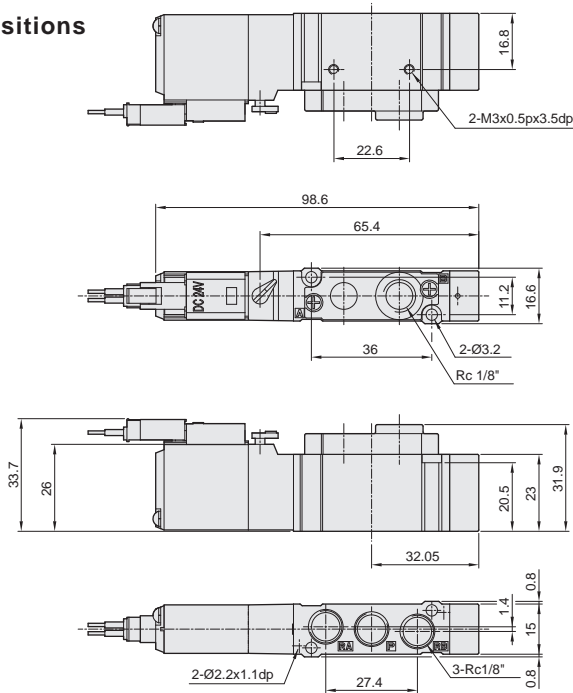
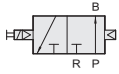

SM 5101 - TB

Single 3 ports 2 positions

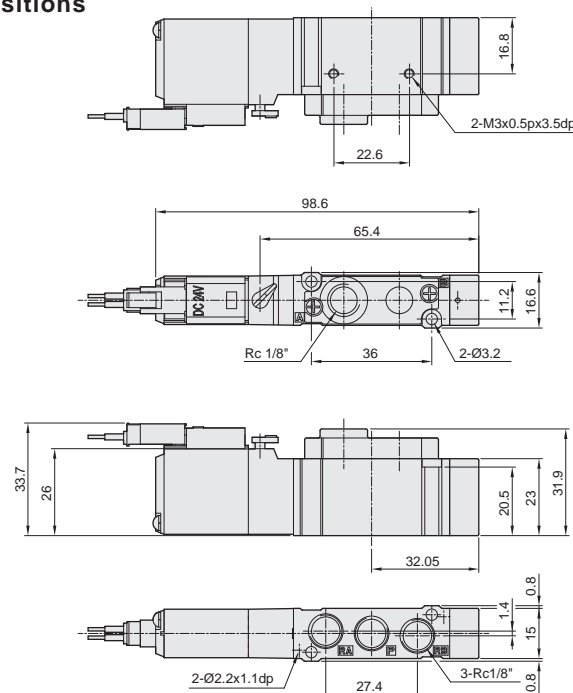
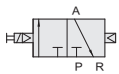

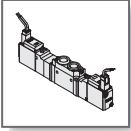

SM series Solenoid valve - SM 5000

External dimension / Standard

CHELIC PNEUMATIC

- ◉ SM 5(3)01
- SM 5(4)01
- SM 5(5)01
- Double 5 ports 3 positions

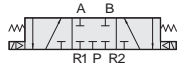

SM-5301 (Normal close) N.C.



SM-5401 (Exhaust) N.F.

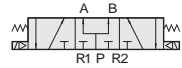

SM-5501 (Normal open) N.O.

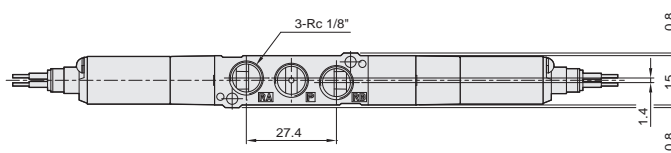
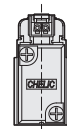
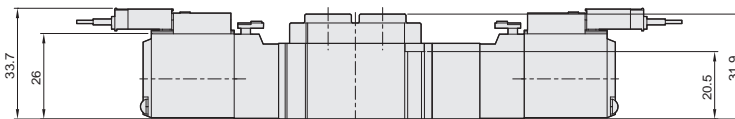
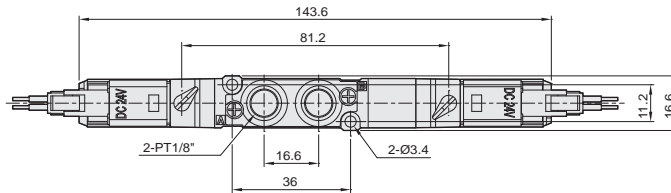
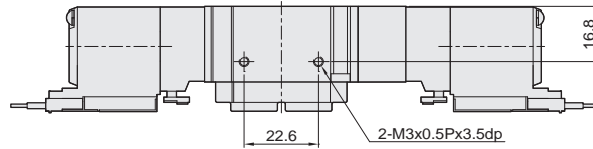

SM
Solenoid Valve

SMB
Solenoid Valve

SMU
Solenoid Valve

SMUB
Solenoid Valve

SR
Solenoid Valve

SRB
Solenoid Valve

SRU
Solenoid Valve

SRUB
Solenoid Valve

SRK
Solenoid Valve

SK
Solenoid Valve

SNK
Solenoid Valve

SKU
Solenoid Valve

SV
Solenoid Valve

SN
Solenoid Valve

SV310
Solenoid Valve

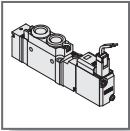

SM series Solenoid valve - SM 5000

External dimension / With connector type

CHELIC PNEUMATIC

- SM 5100-C4(Ø4)
- SM 5100-C6(Ø6)
- SM 5100-C8(Ø8)
- Single 5 ports 2 positions

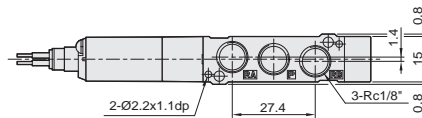
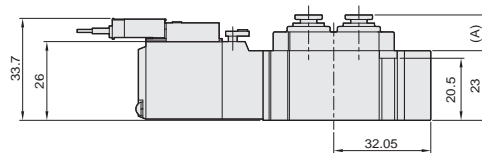
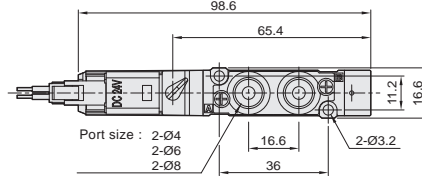
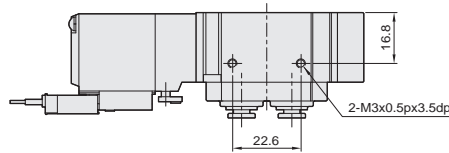

| Model | A |
|-----------|------|
| SM5100-C4 | 11.6 |
| SM5100-C6 | 12.2 |
| SM5100-C8 | 13.5 |

- SM 5200-C4(Ø4)
- SM 5200-C6(Ø6)
- SM 5200-C8(Ø8)
- Double 5 ports 2 positions

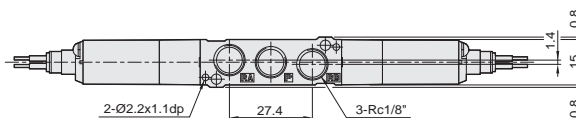
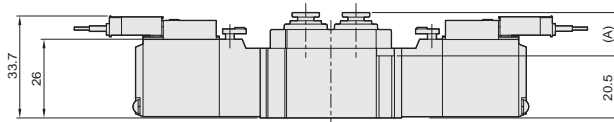
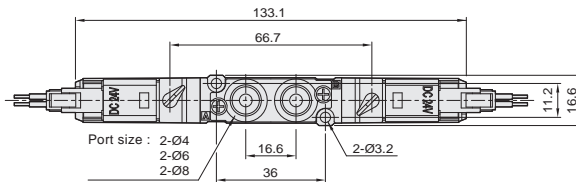
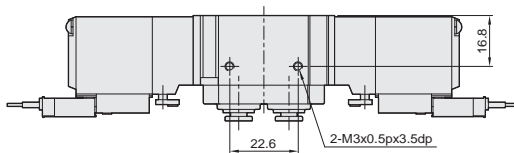
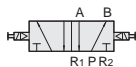

| Model | A |
|-----------|------|
| SM5200-C4 | 11.6 |
| SM5200-C6 | 12.2 |
| SM5200-C8 | 13.5 |

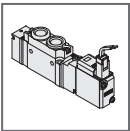

SM series Solenoid valve - SM 5000

External dimension / with connector type / 3 ports 2 positions **CHELIC PNEUMATIC**

- ◉ SM 5100 - C4 - TA - (Ø4)
- SM 5100 - C6 - TA - (Ø6)
- SM 5100 - C8 - TA - (Ø8)
- Single 3 ports 2 positions

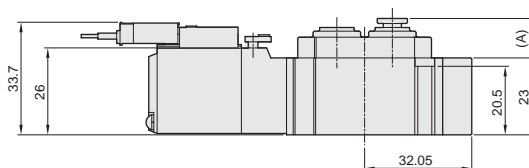
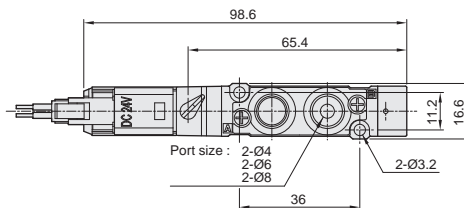
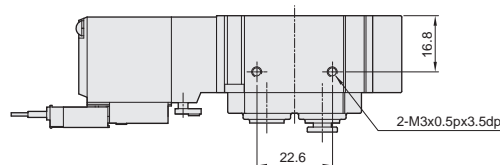
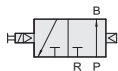

| Model | A |
|--------------|------|
| SM5100-C4-TA | 11.6 |
| SM5100-C6-TA | 12.2 |
| SM5100-C8-TA | 13.5 |

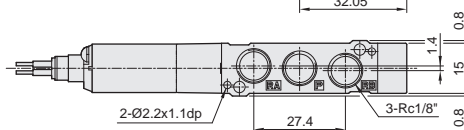

- ◉ SM 5100 - C4 - TB - (Ø4)
- SM 5100 - C6 - TB - (Ø6)
- SM 5100 - C8 - TB - (Ø8)
- Single 3 ports 2 positions

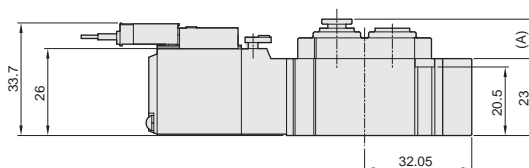
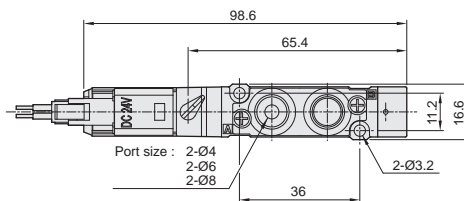
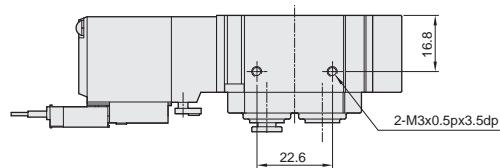
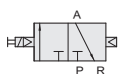

| Model | A |
|--------------|------|
| SM5100-C4-TB | 11.6 |
| SM5100-C6-TB | 12.2 |
| SM5100-C8-TB | 13.5 |

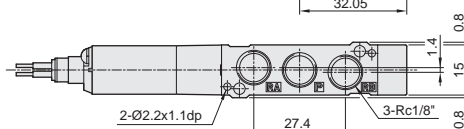

SM
Solenoid Valve

SMB
Solenoid Valve

SMU
Solenoid Valve

SMUB
Solenoid Valve

SR
Solenoid Valve

SRB
Solenoid Valve

SRU
Solenoid Valve

SRUB
Solenoid Valve

SRK
Solenoid Valve

SK
Solenoid Valve

SNK
Solenoid Valve

SKU
Solenoid Valve

SV
Solenoid Valve

SN
Solenoid Valve

SV310
Solenoid Valve

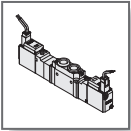

SM series Solenoid valve - SM 5000

External dimension / With connector type

CHELIC PNEUMATIC

- SM 5(3)00-C4(Ø4) · C6(Ø6) · C8(Ø8)
- SM 5(4)00-C4(Ø4) · C6(Ø6) · C8(Ø8)
- SM 5(5)00-C4(Ø4) · C6(Ø6) · C8(Ø8)
- Double 5 ports 3 positions

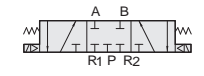

SM-5(3)00 (Normal close) N.C.

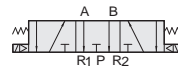

SM-5(4)00 (Exhaust) N.F.

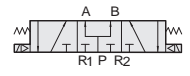

SM-5(5)00 (Normal open) N.O.

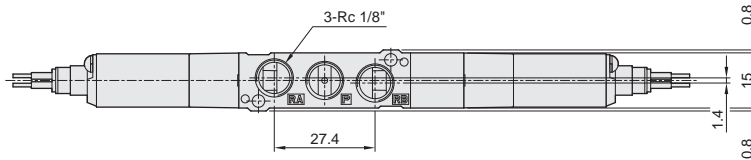
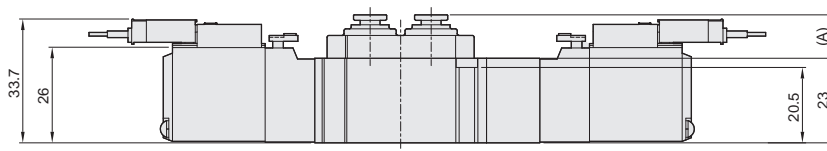
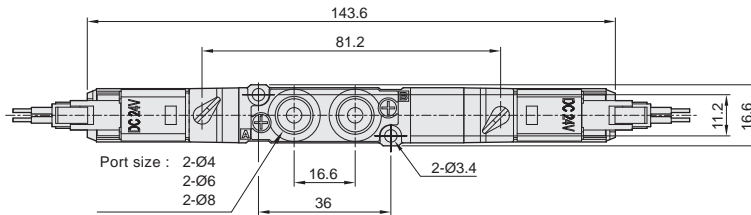
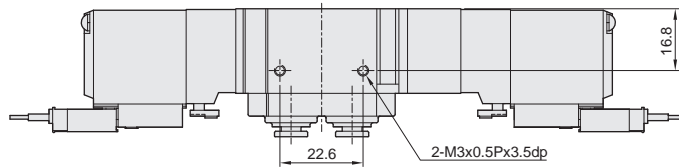

| Model | A |
|-------------|------|
| SM5(3)00-C4 | 11.6 |
| SM5(3)00-C6 | 12.2 |
| SM5(3)00-C8 | 13.5 |

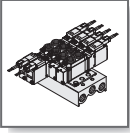

SM series Solenoid valve - SM 5000

External dimension / Manifold type

CHELIC PNEUMATIC

SM 5000 series (Standard) Manifold dimension

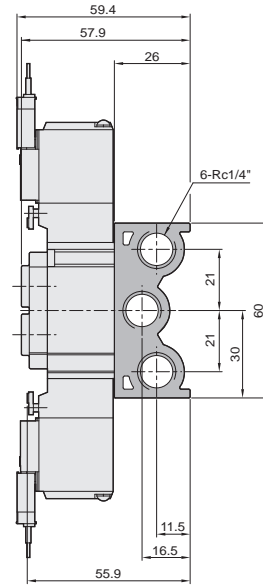
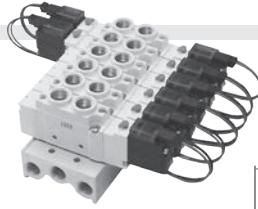
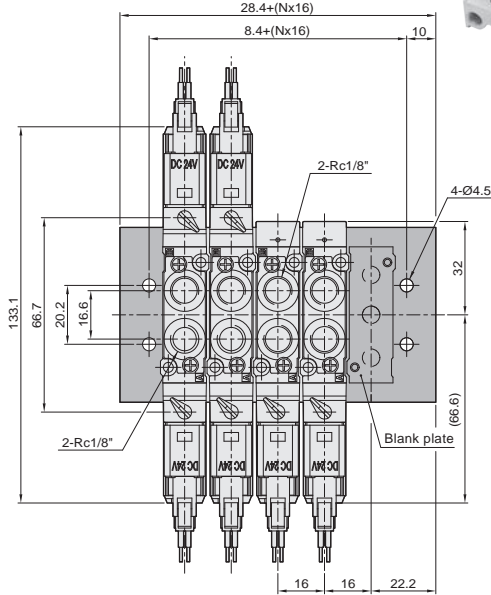

Note : Blank plate with rubber lining is reserved for temporary storagespace of solenoid valves.

SM 5000 series (With connector type) Manifold dimension

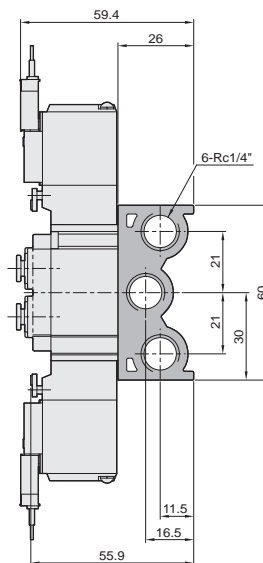
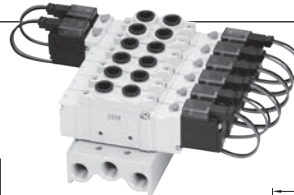
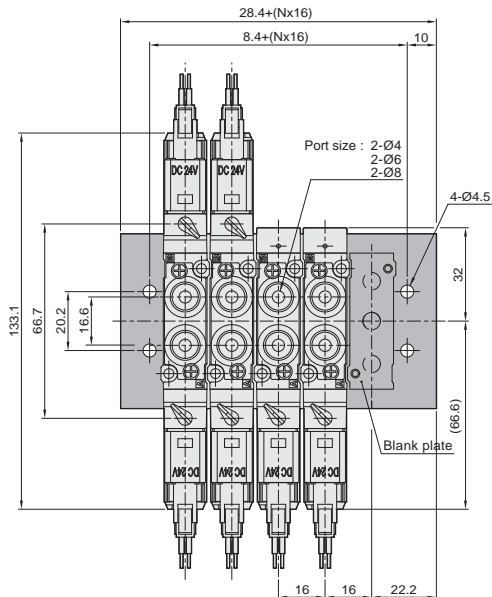

Note : Blank plate with rubber lining is reserved for temporary storage space of solenoid valves.

SM
Solenoid Valve

SMB
Solenoid Valve

SMU
Solenoid Valve

SMUB
Solenoid Valve

SR
Solenoid Valve

SRB
Solenoid Valve

SRU
Solenoid Valve

SRUB
Solenoid Valve

SRK
Solenoid Valve

SK
Solenoid Valve

SNK
Solenoid Valve

SKU
Solenoid Valve

SV
Solenoid Valve

SN
Solenoid Valve

SV310
Solenoid Valve

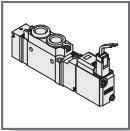

SM series Solenoid valve - SM 7000

External dimension / Standard

CHELIC PNEUMATIC

SM 7101

SM 7102

Single 5 ports 2 positions

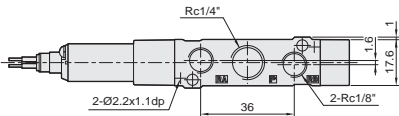
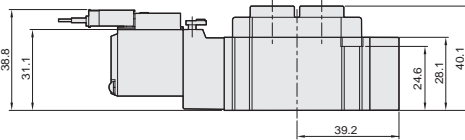
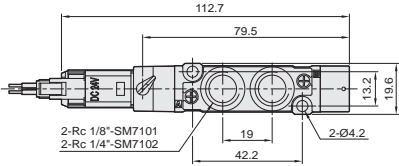
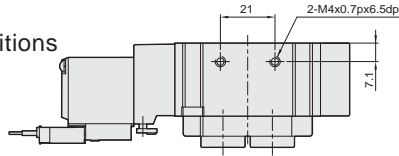

L wire type - L

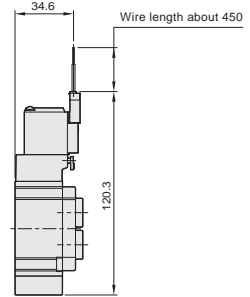

T wire type - T

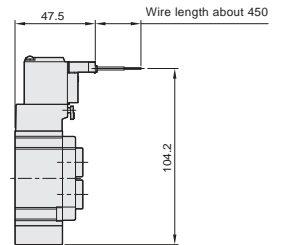

SM 7201

SM 7202

Double 5 ports 2 positions

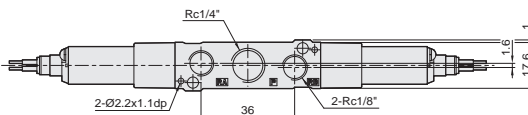
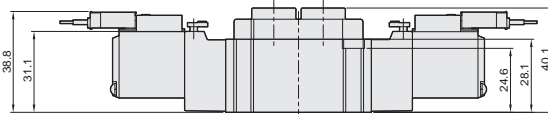
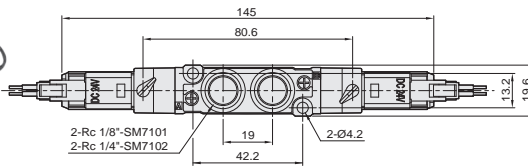
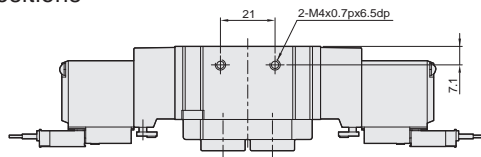

L wire type - L

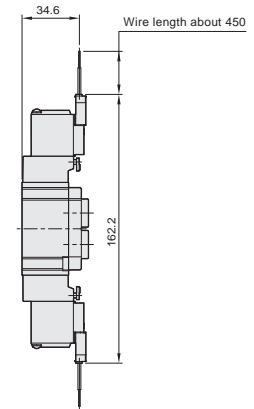

T wire type - T

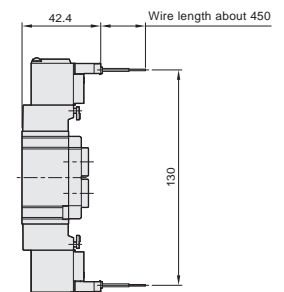

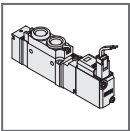

SM series Solenoid valve - SM 7000

External dimension / Standard / 3 ports 2 positions

CHELIC PNEUMATIC

SM 7101 - TA SM 7102 - TA

Single 3 ports 2 positions

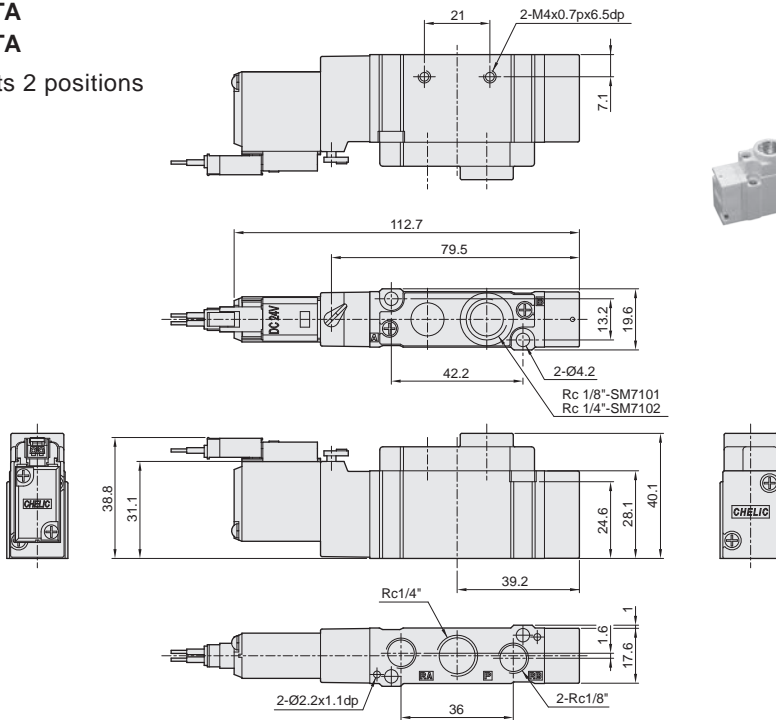
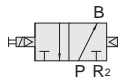

SM 7101 - TB SM 7102 - TB

Single 3 ports 2 positions

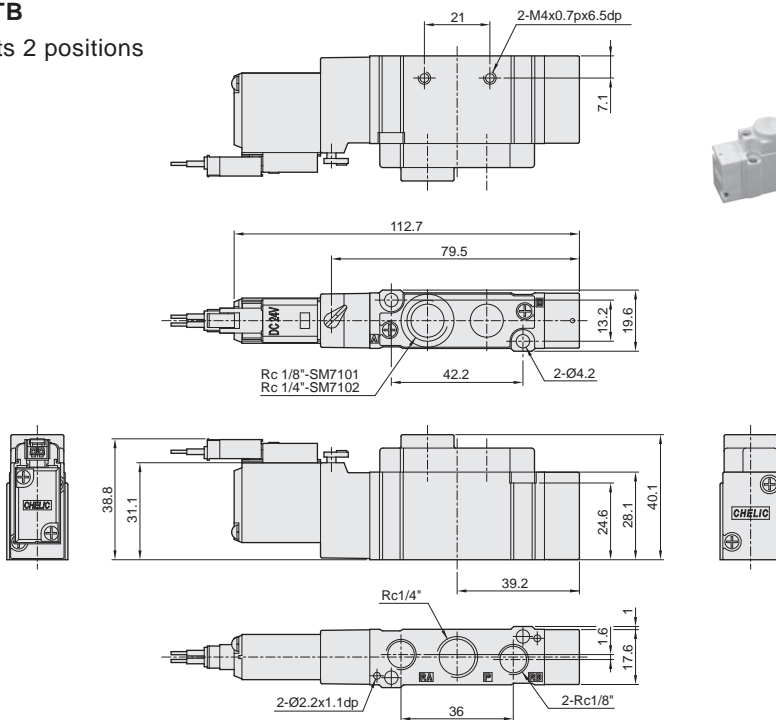
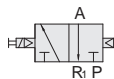

- SM**
Solenoid Valve
- SMB**
Solenoid Valve
- SMU**
Solenoid Valve
- SMUB**
Solenoid Valve
- SR**
Solenoid Valve
- SRB**
Solenoid Valve
- SRU**
Solenoid Valve
- SRUB**
Solenoid Valve
- SRK**
Solenoid Valve
- SK**
Solenoid Valve
- SNK**
Solenoid Valve
- SKU**
Solenoid Valve
- SV**
Solenoid Valve
- SN**
Solenoid Valve
- SV310**
Solenoid Valve

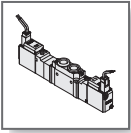

SM series Solenoid valve - SM 7000

External dimension / Standard

CHELIC PNEUMATIC

- SM 7(3)01 \ 02
- SM 7(4)01 \ 02
- SM 7(5)01 \ 02

Double 5 ports 3 positions

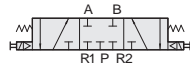

SM-7(3)01 (Normal close) N.C.



SM-7(4)01 (Exhaust) N.F.



SM-7(5)01 (Normal open) N.O.

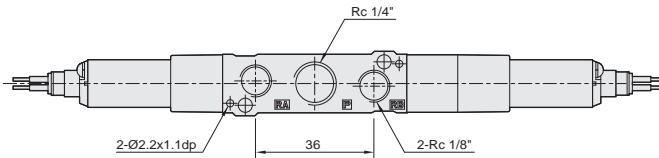
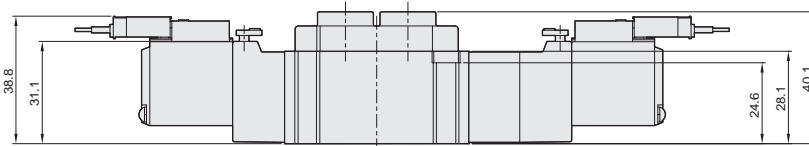
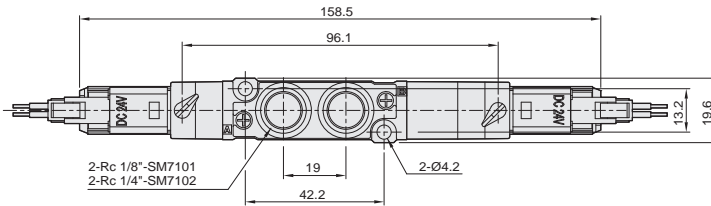
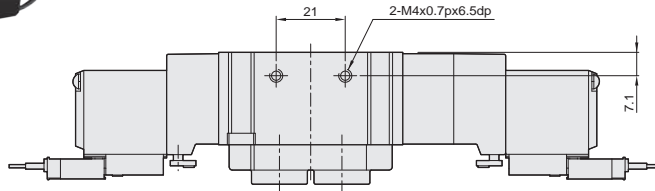

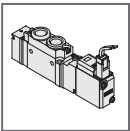

SM series Solenoid valve - SM 7000

External dimension / With connector

CHELIC PNEUMATIC

- SM 7100-C6(Ø6)
- SM 7100-C8(Ø8)
- SM 7100-C10(Ø10)
- Single 5 ports 2 positions

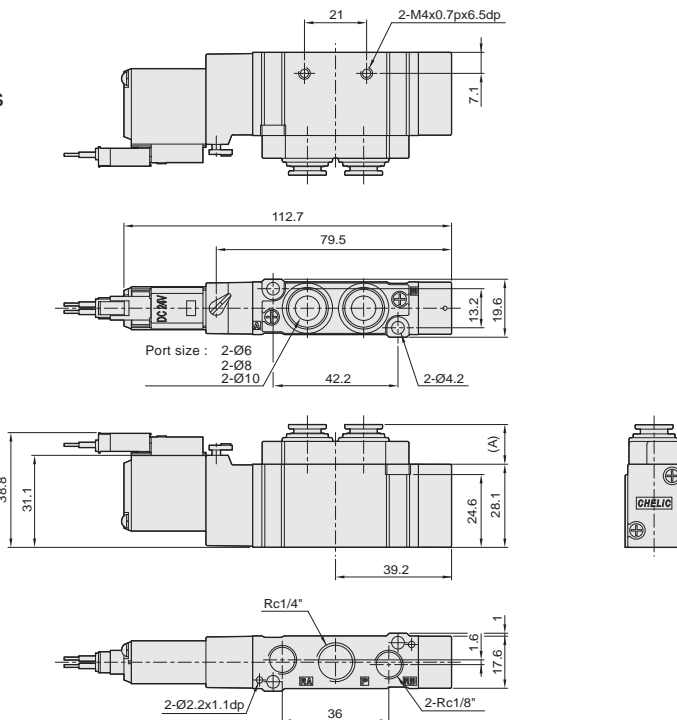

| Model | A |
|------------|------|
| SM7100-C6 | 12.9 |
| SM7100-C8 | 13.3 |
| SM7100-C10 | 18.6 |

- SM 7200-C6(Ø6)
- SM 7200-C8(Ø8)
- SM 7200-C10(Ø10)
- Double 5 ports 2 positions

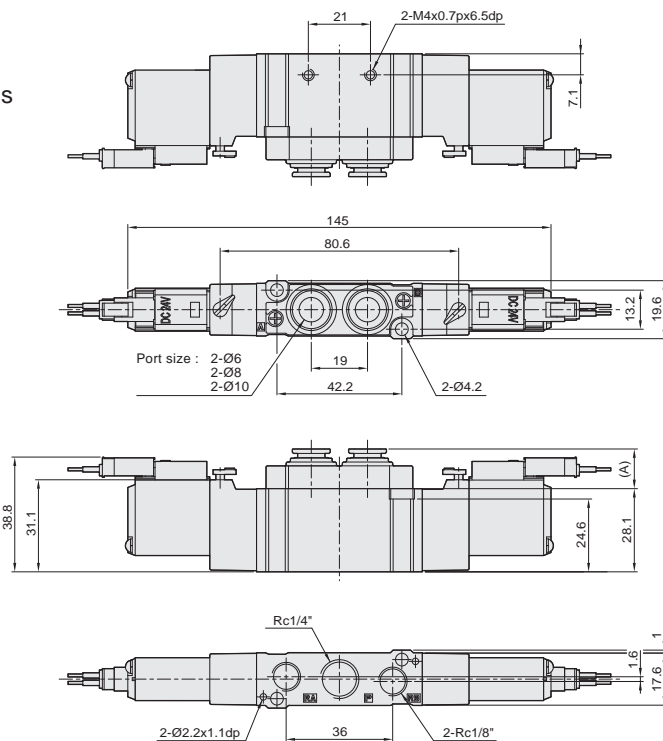
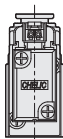
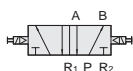

| Model | A |
|------------|------|
| SM7200-C6 | 12.9 |
| SM7200-C8 | 13.3 |
| SM7200-C10 | 18.6 |

SM
Solenoid Valve

SMB
Solenoid Valve

SMU
Solenoid Valve

SMUB
Solenoid Valve

SR
Solenoid Valve

SRB
Solenoid Valve

SRU
Solenoid Valve

SRUB
Solenoid Valve

SRK
Solenoid Valve

SK
Solenoid Valve

SNK
Solenoid Valve

SKU
Solenoid Valve

SV
Solenoid Valve

SN
Solenoid Valve

SV310
Solenoid Valve

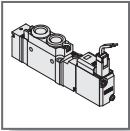

SM series Solenoid valve - SM 7000

External dimension / With connector / 3ports 2 positions CHELIC PNEUMATIC

- ◉ SM 7100 - C6 - TA - (Ø6)
 - SM 7100 - C8 - TA - (Ø8)
 - SM 7100 - C10 - TA - (Ø10)
- Single 3 ports 2 positions

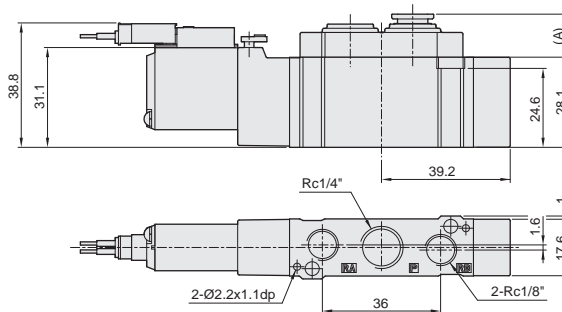
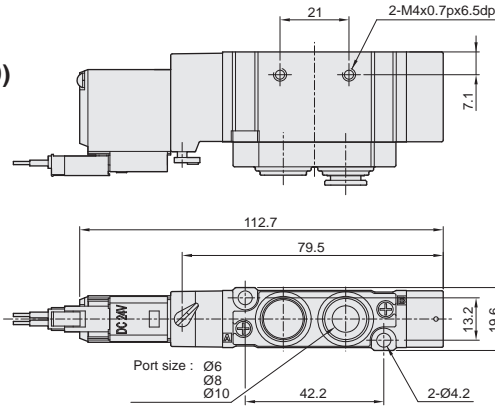
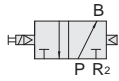

| Model | A |
|---------------|------|
| SM7100-C6-TA | 12.9 |
| SM7100-C8-TA | 13.3 |
| SM7100-C10-TA | 18.6 |

- ◉ SM 7100 - C6 - TB - (Ø6)
 - SM 7100 - C8 - TB - (Ø8)
 - SM 7100 - C10 - TB - (Ø10)
- Single 3 ports 2 positions

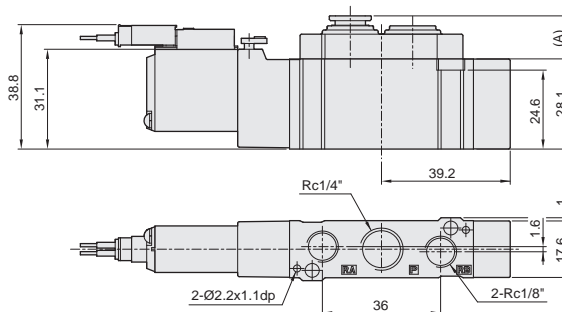
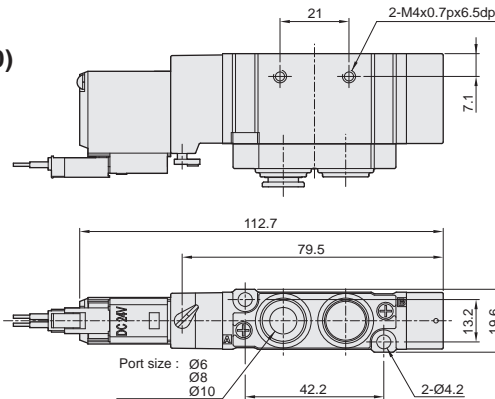
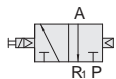

| Model | A |
|---------------|------|
| SM7100-C6-TB | 12.9 |
| SM7100-C8-TB | 13.3 |
| SM7100-C10-TB | 18.6 |

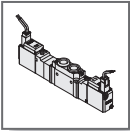

SM series Solenoid valve - SM 7000

External dimension / With connector

CHELIC PNEUMATIC

- SM 7(3)00-C6(Ø6) 、 C8(Ø8) 、 C10(Ø10)
- SM 7(4)00-C6(Ø6) 、 C8(Ø8) 、 C10(Ø10)
- SM 7(5)00-C6(Ø6) 、 C8(Ø8) 、 C10(Ø10)
- Double 5 ports 3 positions

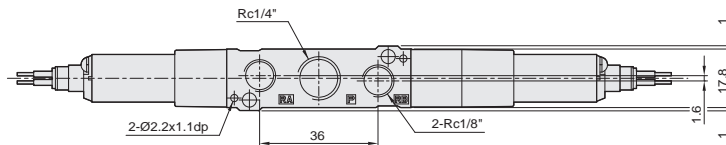
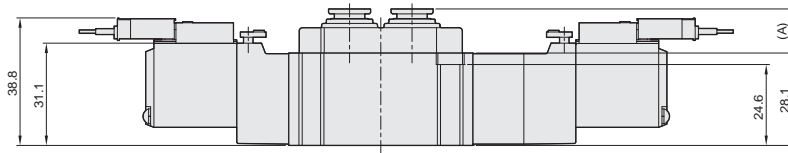
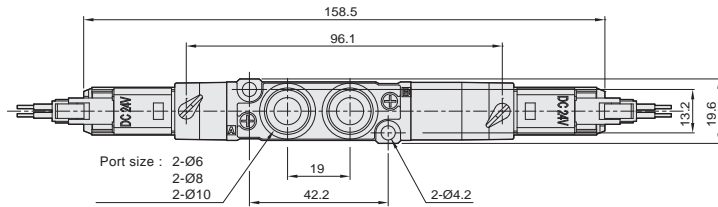
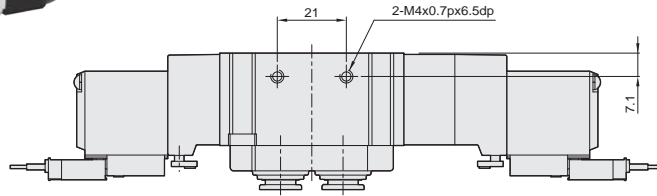
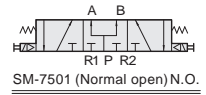
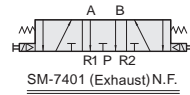
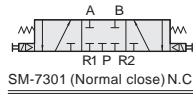

| Model | A |
|------------|------|
| SM7100-C6 | 12.9 |
| SM7100-C8 | 13.3 |
| SM7100-C10 | 18.6 |

SM
Solenoid Valve

SMB
Solenoid Valve

SMU
Solenoid Valve

SMUB
Solenoid Valve

SR
Solenoid Valve

SRB
Solenoid Valve

SRU
Solenoid Valve

SRUB
Solenoid Valve

SRK
Solenoid Valve

SK
Solenoid Valve

SNK
Solenoid Valve

SKU
Solenoid Valve

SV
Solenoid Valve

SN
Solenoid Valve

SV310
Solenoid Valve

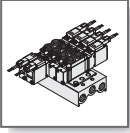

SM series Solenoid valve - SM 7000

External dimension / Manifold type

CHELIC PNEUMATIC

SM 7000 series (Standard) Manifold dimension

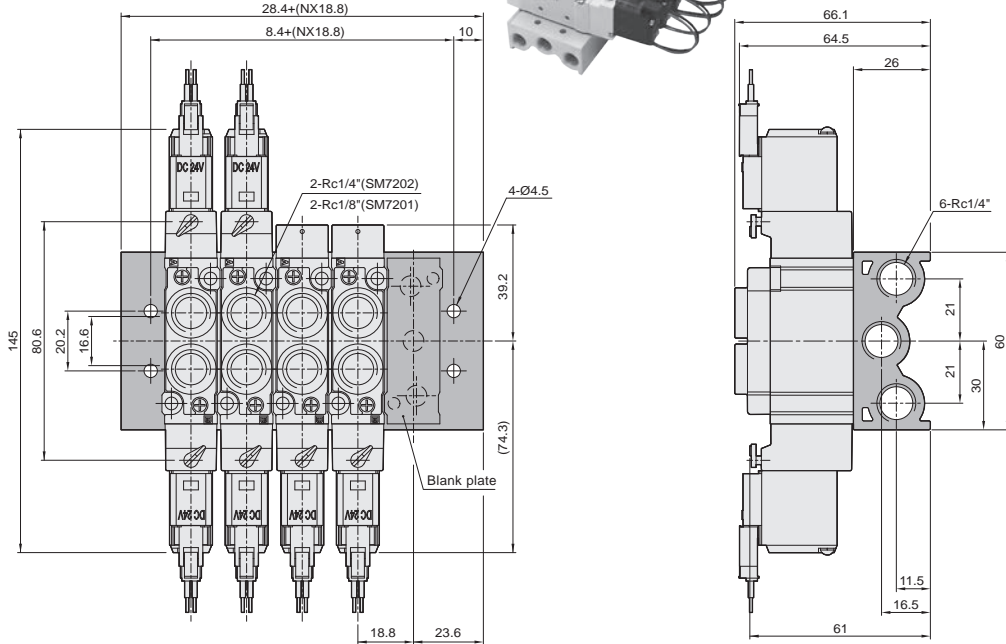

Note : Blank plate with rubber lining is reserved for temporary storage space of solenoid valves.

SM 7000 series (With connector type) Manifold dimension

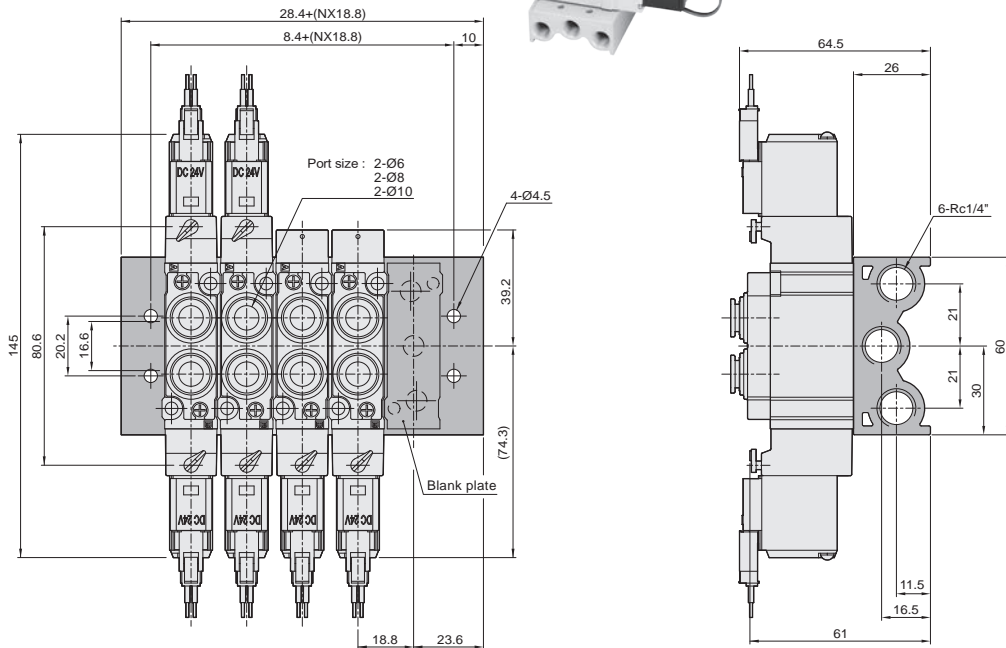

Note : Blank plate with rubber lining is reserved for temporary storage space of solenoid valves.

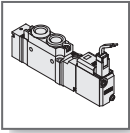

SM series Solenoid valve - SM 9000

External dimension / Standard

CHELIC PNEUMATIC

SM 9102

SM 9103

Single 5 ports 2 positions

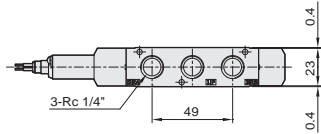
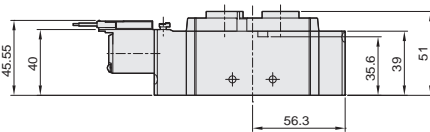
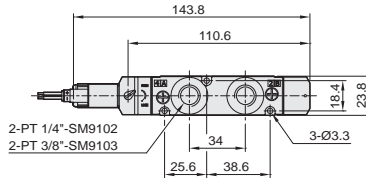
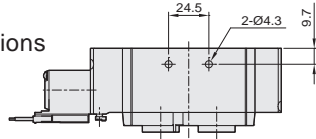
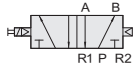

L wire type - L

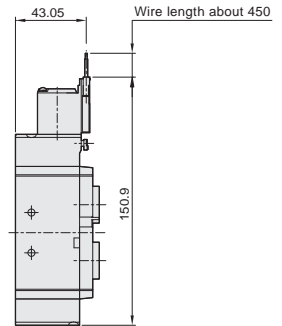

T wire type - T

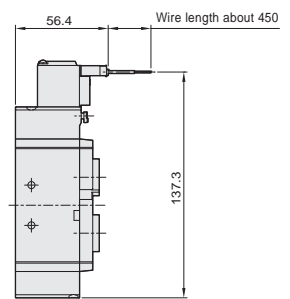

SM 9202

SM 9203

Double 5 ports 2 positions

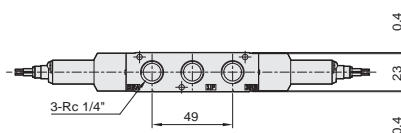
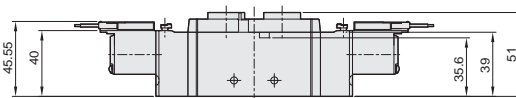
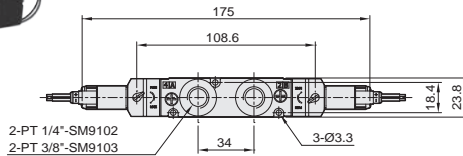
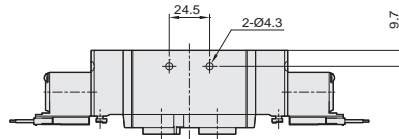

L wire type - L

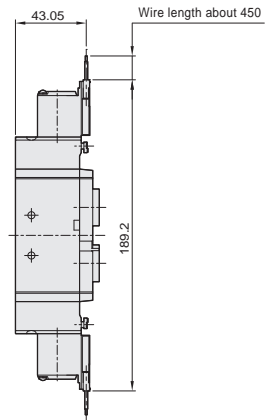

T wire type - T

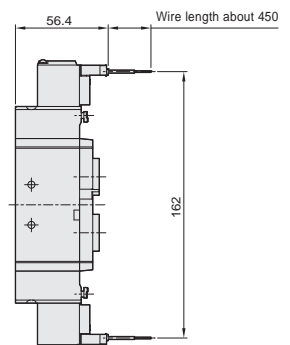

SM
Solenoid Valve

SMB
Solenoid Valve

SMU
Solenoid Valve

SMUB
Solenoid Valve

SR
Solenoid Valve

SRB
Solenoid Valve

SRU
Solenoid Valve

SRUB
Solenoid Valve

SRK
Solenoid Valve

SK
Solenoid Valve

SNK
Solenoid Valve

SKU
Solenoid Valve

SV
Solenoid Valve

SN
Solenoid Valve

SV310
Solenoid Valve

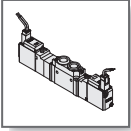

SM series Solenoid valve - SM 9000

External dimension / Standard

CHELIC PNEUMATIC

☛ SM 9(3)02 \ 03

SM 9(4)02 \ 03

SM 9(5)02 \ 03

Double 5 ports 3 positions

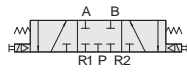

SM-9(3)02 (Normal close) N.C.

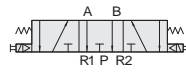

SM-9(4)02 (Exhaust) N.F.

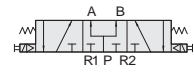

SM-9(5)02 (Normal open) N.O.

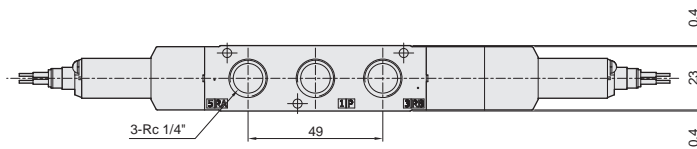
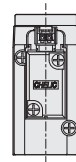
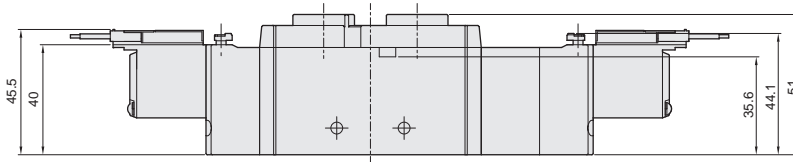
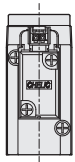
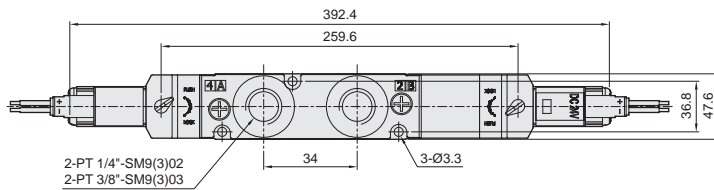
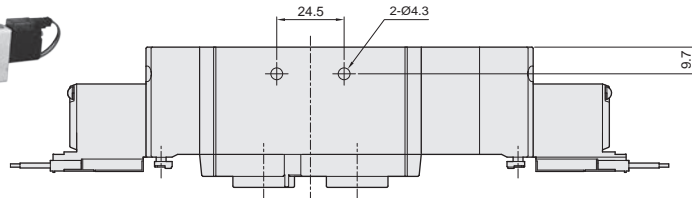

☛ L wire type - L

☛ T wire type - T

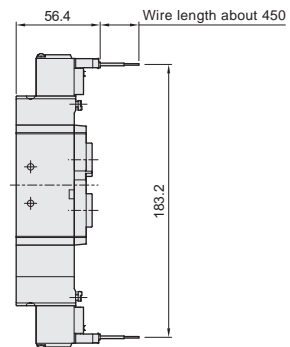
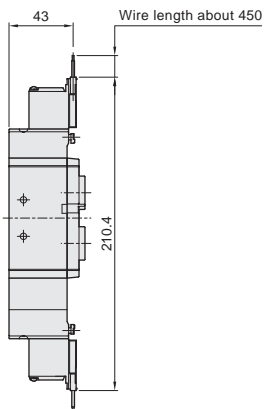

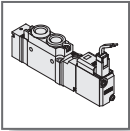

SM series Solenoid valve - SM 9000

External dimension / With connector

CHELIC PNEUMATIC

- SM 9100-C8(Ø8)
- SM 9100-C10(Ø10)
- SM 9100-C12(Ø12)
- Single 5 ports 2 positions

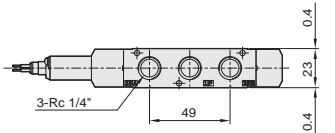
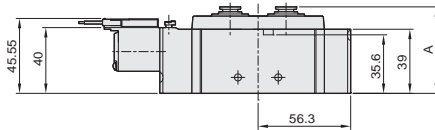
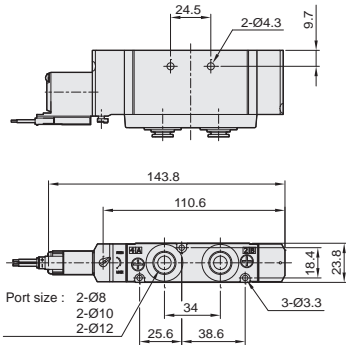

| Model | A |
|------------|------|
| SM9102-C8 | 52.5 |
| SM9102-C10 | 57.6 |
| SM9102-C12 | 60.6 |

- L wire type - L

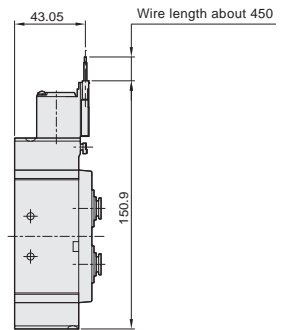

- T wire type - T

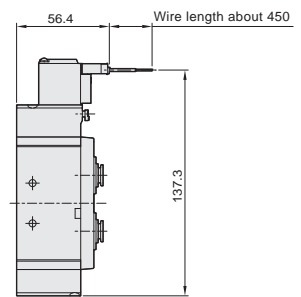

- SM 9200-C8(Ø8)
- SM 9200-C10(Ø10)
- SM 9200-C12(Ø12)
- Double 5 ports 2 positions

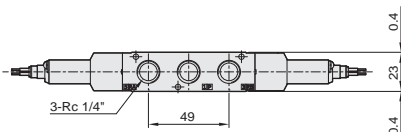
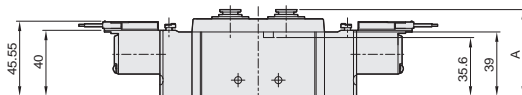
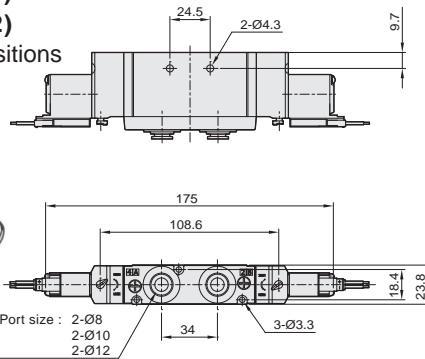
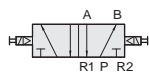

| Model | A |
|------------|------|
| SM9102-C8 | 52.5 |
| SM9102-C10 | 57.6 |
| SM9102-C12 | 60.6 |

- L wire type - L

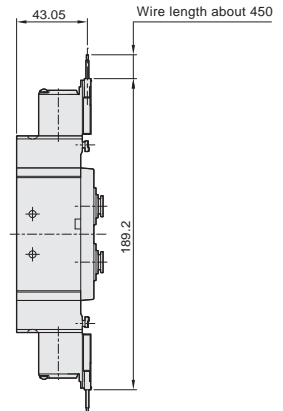

- T wire type - T

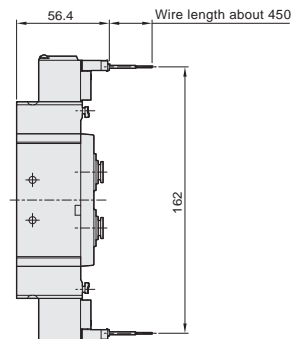

SM
Solenoid Valve

SMB
Solenoid Valve

SMU
Solenoid Valve

SMUB
Solenoid Valve

SR
Solenoid Valve

SRB
Solenoid Valve

SRU
Solenoid Valve

SRUB
Solenoid Valve

SRK
Solenoid Valve

SK
Solenoid Valve

SNK
Solenoid Valve

SKU
Solenoid Valve

SV
Solenoid Valve

SN
Solenoid Valve

SV310
Solenoid Valve

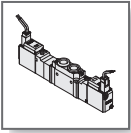

SM series Solenoid valve - SM 9000

External dimension / With connector

CHELIC PNEUMATIC

- SM 9(3)00-C8(Ø8) 、 C10(Ø10) 、 C12(Ø12)
 - SM 9(4)00-C8(Ø8) 、 C10(Ø10) 、 C12(Ø12)
 - SM 9(5)00-C8(Ø8) 、 C10(Ø10) 、 C12(Ø12)
- Double 5 ports 3 positions

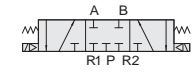

SM-9(3)00 (Normal close) N.C.

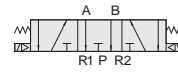

SM-9(4)00 (Exhaust) N.F.

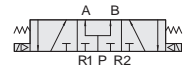

SM-9(5)00 (Normal open) N.O.

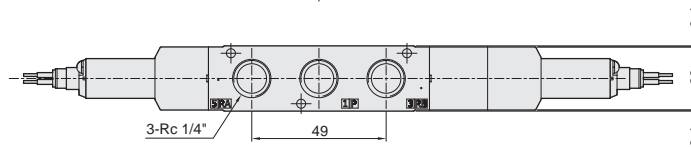
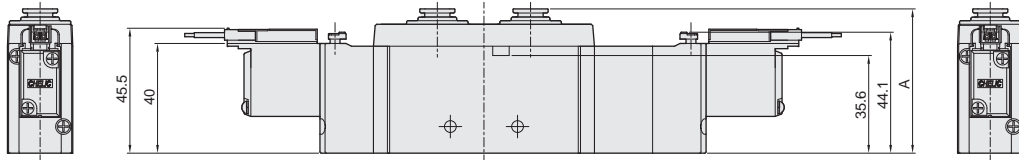
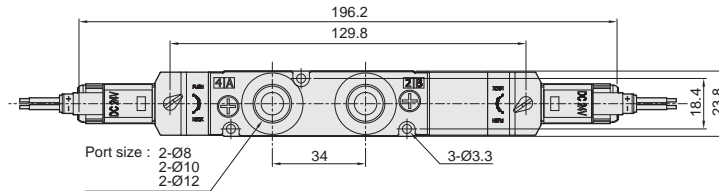
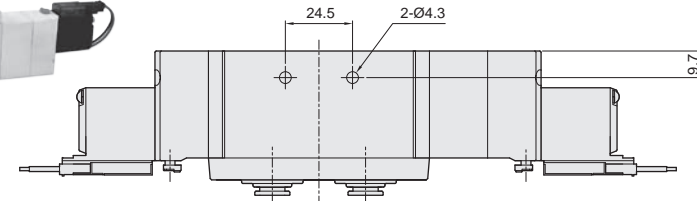

| Model | A |
|------------|------|
| SM9102-C8 | 52.5 |
| SM9102-C10 | 57.6 |
| SM9102-C12 | 60.6 |

● L wire type - L

● T wire type - T

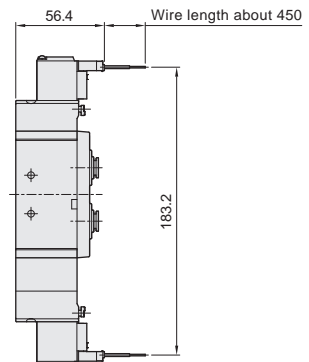
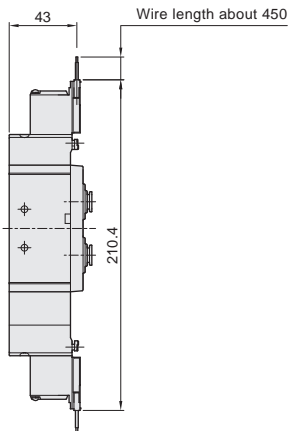

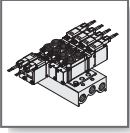

SM series Solenoid valve - SM 9000

External dimension / Manifold type

CHELIC PNEUMATIC

SM 9000 series (Standard) Manifold dimension

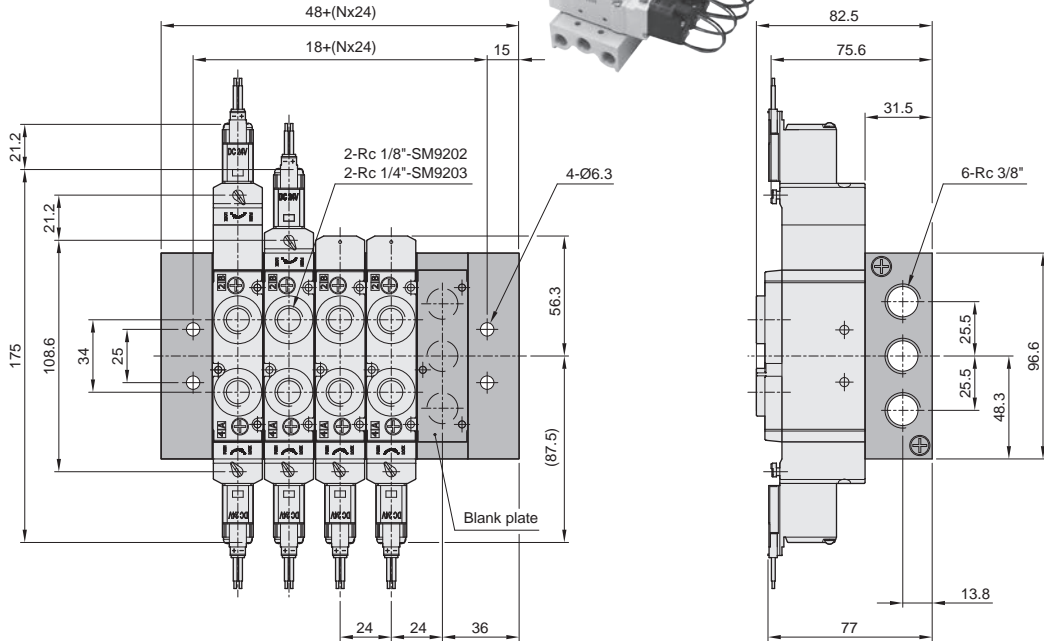

Note : Blank plate with rubber lining is reserved for temporary storage space of solenoid valves.

SM 9000 series (With connector type) Manifold dimension

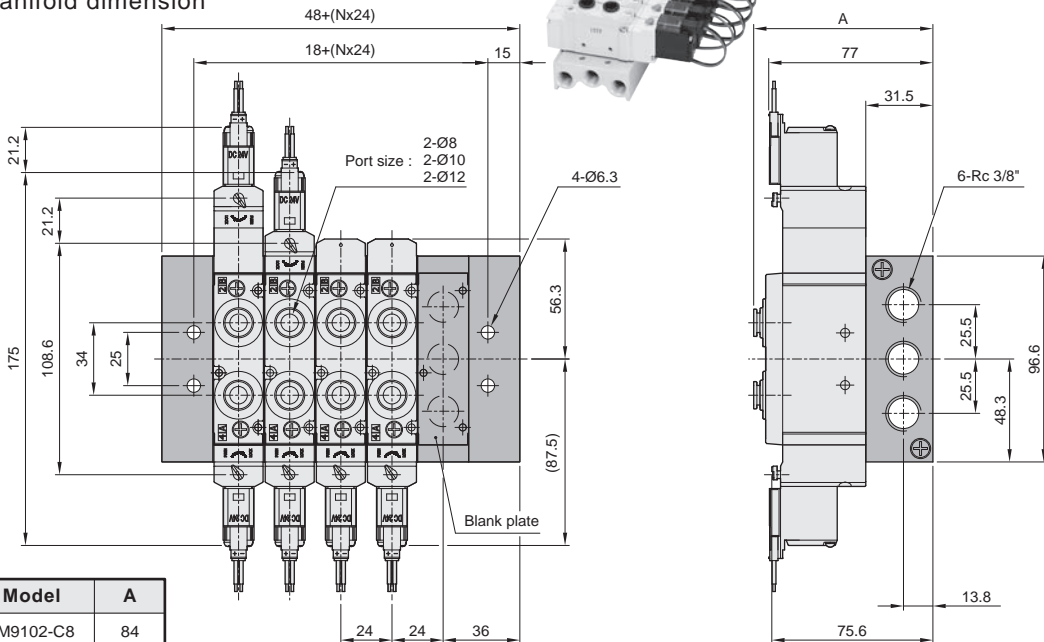

| Model | A |
|------------|------|
| SM9102-C8 | 84 |
| SM9102-C10 | 89.1 |
| SM9102-C12 | 92.1 |

Note : Blank plate with rubber lining is reserved for temporary storage space of solenoid valves.

SM
Solenoid Valve

SMB
Solenoid Valve

SMU
Solenoid Valve

SMUB
Solenoid Valve

SR
Solenoid Valve

SRB
Solenoid Valve

SRU
Solenoid Valve

SRUB
Solenoid Valve

SRK
Solenoid Valve

SK
Solenoid Valve

SNK
Solenoid Valve

SKU
Solenoid Valve

SV
Solenoid Valve

SN
Solenoid Valve

SV310
Solenoid Valve

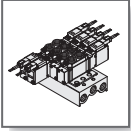

SM series Solenoid valve - SM 9000

Accessories and Installation

CHELIC PNEUMATIC

Manifold

SM-5000,7000,9000 series

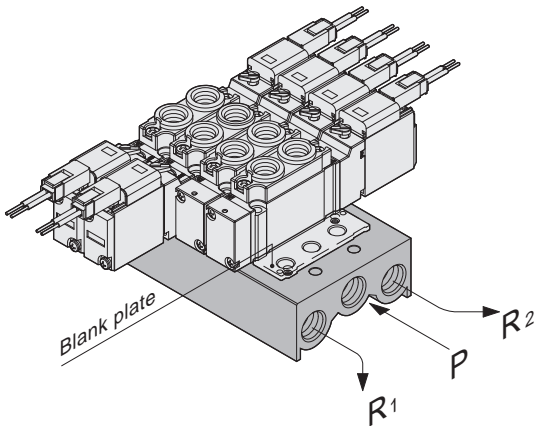

Manifold

SM-5000,7000,9000 series

※ The accessories of blank plate.



| | Blank plate | Rubber lining | Mounting screw |
|----------------|-------------|---------------|----------------|
| SM-5000 series | MSM05041 | MSM05039 | M3X8L MSM05040 |
| SM-7000 series | MSM07041 | MSM07039 | M4X8L MSM07040 |
| SM-9000 series | MSM09041 | MSM09039 | M3X8L MSM09040 |

With indicator light all this series with indicator light and voltage protection circuit.

