

N 87 SERIES EXPLOSION PROOF PUMPS

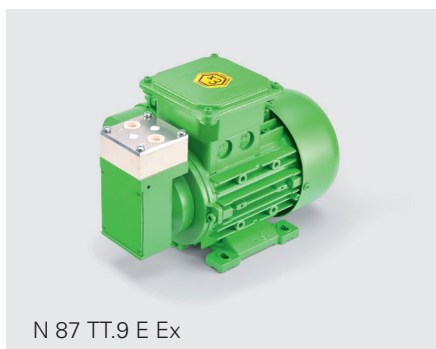

N 87 TT.9 E Ex

ADVANTAGES

- High chemical resistance
- Robust design
- Copes well with vapor and condensation
- High level of performance in a compact size
- Excellent price/performance ratio
- Motor approved in accordance with ATEX/IECEX
- High level of gas tightness: approx. 6×10^{-3} mbar x l/s

POSSIBLE AREAS OF USE

- Environmental monitoring – especially in potentially explosive fields
- Process industry
- Chemical industry

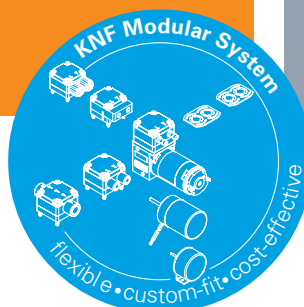

Please visit our website
www.knf.com
to get more information

PERFORMANCE DATA

Series model	N 87				
Material design	TT.9 E Ex				
Pump head	PVDF				
Diaphragm	PTFE-coated				
Valves	FFPM				
Flow rate at atm. pressure (l/min)	7.5				
Ultimate vacuum (mbar abs.)	140				
Max. operating pressure (bar rel./psig)	1.5/21.8				
Permissible ambient temperature (°C)	+5 ... +40				
Permissible media temperature (°C)	+5 ... +40				
Weight (kg/lbs)	6.7/14.8				

ELECTRICAL DATA

Voltage (V)	230	220	115	110	100
Motor	Capacitor motor				
Protection class motor	IP 66				
Protection class pump	IP 55				
Frequency (Hz)	50/60				
Power P ₂ (W)	60	120			
I _N (A)	0.6/0.7	1.09/1.18	2.18/2.12	2.18/2.10	2.28/2.26
Explosion protection pump parts	Ex II 2G Ex h IIB+H2 T4 Gb				
Explosion protection capacitor motor	Ex II 2G Ex dbeb IIC T4				

N 87 TT.9 E EX

PERFORMANCE DATA

Series model	Flow rate at atm. pressure (l/min) ¹⁾	Max. operating pressure (bar rel./psig)	Ultimate vacuum (mbar abs.)
N 87 TT.9 E Ex	7.5	1.5/21.8	140

¹⁾ Liter at STP

N 87 TT.9 E EX

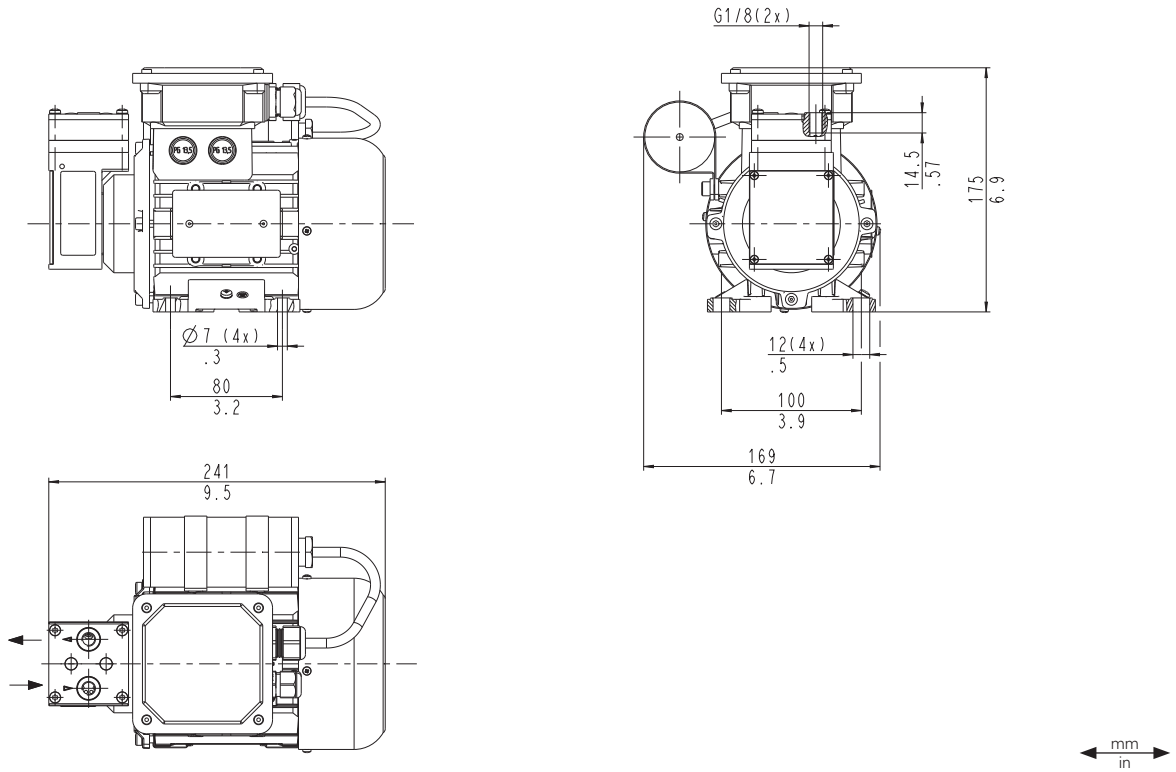

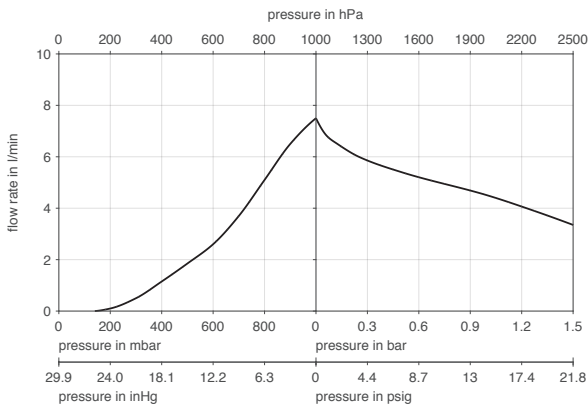

N 87 TT.9 E EX

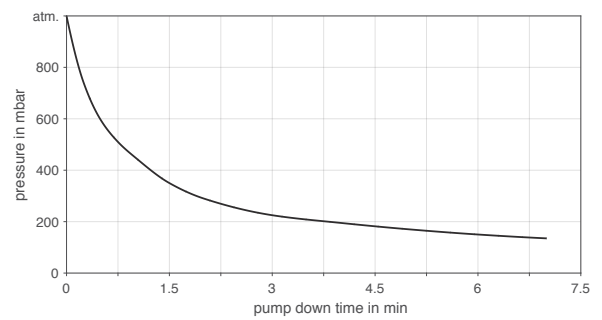

N 87 TT.9 E EX | PUMP DOWN TIME FOR 5 LITER VESSEL



ACCESSORIES

Description	Illustration	Part No.	Details
Hose connector for tube ID 6		123363	PVDF, G1/8
Inserted screw connection ID 6		014049	PVDF, G1/8

SPARE PARTS:

Description	Part No.
Spare parts kit N 87 TT.9 E Ex (1x valve plate, 1x diaphragm, 2x screw caps)	322292

The performance values for the series models shown on this data sheet were determined under test conditions. The actual performance values may differ and depend in particular on the usage conditions and therefore on the specific application, on the parameters of the components involved in the user's system and on any technical modifications carried out which deviate from the standard configuration or the as delivered condition.

If individual designs have been created for specific customers on the basis of series models, other technical performance data may apply. Before operation begins, the relevant operating instructions and/or assembly or installation instructions should be read and the safety information contained in these instructions should be noted. KNF reserves the right to make changes to the product and the associated documentation without prior notice to the customer.



www.knf.com